



INSTRUCTION MANUAL

DUAL BAND FM TRANSCEIVER

IC-2800H

This device complies with Part 15 of the FCC rules. Operation is subject to the following two conditions: (1) This device may not cause harmful interference, and (2) this device must accept any interference received, including interference that may cause undesired operation.

Icom Inc.

FOREWORD

READ ALL INSTRUCTIONS carefully and completely before using the transceiver.

SAVE THIS INSTRUCTION MANUAL — This instruction manual contains important operating instructions for the IC-2800H.

EXPLICIT DEFINITIONS

The explicit definitions below apply to this instruction manual.

WORD	DEFINITION
⚠ WARNING	Personal injury, fire hazard or electric shock may occur.
CAUTION	Equipment damage may occur.
NOTE	If disregarded, inconvenience only. No risk of personal injury, fire or electric shock.



Versions of the IC-2800H which display the “CE” symbol on the serial number seal comply with the European harmonised standard ETS300 684 (EMC product standard for Commercially Available Amateur Radio Equipment).

CAUTIONS

⚠ WARNING! NEVER connect the transceiver to an AC outlet. This may pose a fire hazard or result in an electric shock.

⚠ WARNING! NEVER operate the transceiver while driving a vehicle. Safe driving requires your full attention—anything less may result in an accident.

⚠ WARNING! HIGH VOLTAGE! NEVER disassemble the remote controller. There is a high voltage circuit inside.

NEVER connect the transceiver to a power source of more than 16 V DC or using reverse polarity. This will ruin the transceiver.

NEVER cut the DC power cable between the DC plug and fuse holder. If an incorrect connection is made after cutting, the transceiver may be damaged.

NEVER place the transceiver where normal operation of the vehicle may be hindered or where it could cause bodily injury.

NEVER let objects impede the operation of the cooling fan on the rear panel.

DO NOT push the PTT when not actually desiring to transmit.

DO NOT operate the transceiver near unshielded electrical blasting caps or in an explosive atmosphere.

During mobile operation, **DO NOT** operate the transceiver without running the vehicle's engine. When transceiver power is ON and your vehicle's engine is OFF, the vehicle's battery will soon become exhausted.

AVOID using or placing the transceiver in direct sunlight or in areas with temperatures below -10°C ($+14^{\circ}\text{F}$) or above $+60^{\circ}\text{C}$ ($+140^{\circ}\text{F}$).

AVOID the use of chemical agents such as benzine or alcohol when cleaning, as they can damage the transceiver's surfaces.

Place unit in a secure place to avoid inadvertent use by children.

BE CAREFUL! The transceiver will become hot when operating it continuously for long periods.

USE Icom microphones only (supplied or optional). Other manufacturer's microphones have different pin assignments and may damage the transceiver if attached.

For LCD display

DO NOT press the LCD screen. Excessive pressure may cause permanent damage to the LCD.

DO NOT tap or scratch the LCD using sharp objects.

BE CAREFUL when cleaning the LCD. Dust can easily scratch the surface.

LCDs are produced using high-density manufacturing technology resulting in 99.98% active dots, however, up to 0.02% of the dots may be non-active and/or continuously active. This is normal and does not indicate LCD malfunction.

Uneven areas may be displayed depending on display contents in some cases.

After displaying the same screen continuously for long periods, image 'burn-in' may occur. In such cases, turn the power OFF and discontinue operation for at least 24 hours.

For U.S.A. only

CAUTION: Changes or modifications to this device, not expressly approved by Icom Inc., could void your authority to operate this device under FCC regulations.

TABLE OF CONTENTS

1 SUPPLIED ACCESSORIES	1	■ Selecting output power	25	■ Transferring scratch pad memory contents	41	15 OTHER FUNCTIONS	63–75
2 PANEL DESCRIPTION	2–13	■ One-touch PTT function	25	9 SCAN OPERATION	42–46	■ Beep tones	63
■ Controller unit	2	6 REPEATER OPERATION ...	26–31	■ Scan types	42	■ Time-out timer	63
■ Function display	4	■ Accessing a repeater	26	■ Full/programmed scan	43	■ Auto power-off function	64
■ Basic function menu	6	■ 1750 Hz tone	28	■ Selecting scan edges	44	■ Cooling fan	64
■ Main unit	8	■ Subaudible tone	29	■ Memory scan	45	■ Squelch delay	65
■ HM-98 microphone	10	■ Offset frequency	30	■ Skip channel setting	46	■ Sub band mute	65
■ HM-97/118N microphone	13	■ Auto repeater function	31	■ Scan resume condition	46	■ Sub band busy beep	66
3 INSTALLATION	14–17	7 MEMORY/CALL CHANNELS	32–39	10 BAND SCOPE	47	■ Automatic RF attenuator	66
■ Location	14	■ General	32	■ Operation	47	■ Memory name indication	67
■ Mounting with the mounting bracket	14	■ Programming during selection	32	11 PRIORITY WATCH	48–49	■ HM-98 [F-1]/[F-2] keys	67
■ Mounting the remote controller	15	■ Programming after selection	33	■ Priority watch types	48	■ HM-97/118 [UP]/[DN] keys	68
■ Battery connection	15	■ Transferring memory contents to another memory	33	■ Priority watch operation	48	■ Display contrast	68
■ DC power supply connection	16	■ Programming during selection via the microphone	34	12 SUBAUDIBLE TONE OPERATION	50–53	■ Display brightness	69
■ Cable connection	16	■ Programming after selection via the microphone	34	■ Tone squelch operation	50	■ Indication type	69
■ Antenna installation	17	■ Transferring memory contents to another memory via the microphone	35	■ Pocket beep operation	52	■ My call function	69
4 FREQUENCY SETTING	18–22	■ Memory clear	36	■ Tone scan	53	■ Packet operation	70
■ Preparation	18	■ Alphanumeric display	37	13 DTMF MEMORY	54–56	■ Video monitor function	73
■ Lock functions	19	■ Call channel	38	■ Programming a DTMF code	54	■ Demonstration display	74
■ Using the tuning dial	20	8 SCRATCH PAD MEMORY ...	40–41	■ Transmitting a DTMF code	55	■ AM/FM narrow mode	74
■ Using the [▲]/[▼] keys	20	■ What is a scratch pad memory?	40	■ DTMF speed	56	■ Fuse replacement	74
■ Setting a tuning step	21	■ Calling up a scratch pad memory	40	14 WIRELESS OPERATION	57–62	■ Partial reset	75
■ Using the keypad	22			■ Connection	57	■ All reset	75
5 BASIC OPERATION	23–25			■ HM-90 wireless microphone	57	16 CS-2800 CLONING SOFTWARE	76–79
■ Receiving	23			■ EX-1759 installation	58	17 TROUBLESHOOTING	80
■ Monitor function	24			■ HM-90 switches	59	18 OPTIONS	81
■ Audio mute function	24			■ Microphone address	62	19 SPECIFICATIONS	82–83
■ Transmitting	24						

SUPPLIED ACCESSORIES

1

The transceiver comes with the following accessories.

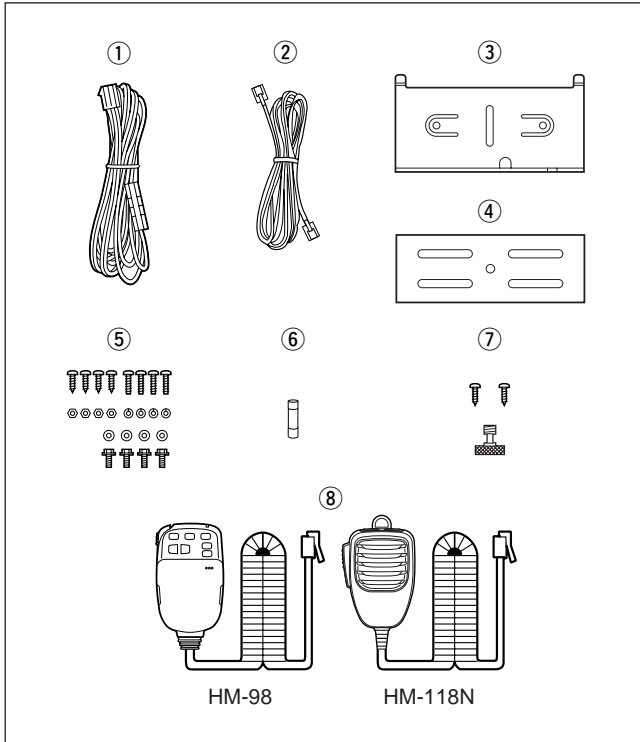

Qty.

- ① DC power cable (OPC-346) 1
- ② Remote controller cable*1 1
- ③ Remote controller mounting bracket (MB-73) 1
- ④ Main unit mounting bracket 1
- ⑤ Mounting screws, nuts and washers 1 set
- ⑥ Fuse (FGB 20 A) 1
- ⑦ Remote controller mounting screws and nut 1 set
- ⑧ Microphone*2 (HM-98/97/118N) 1

*1 A ferrite core is attached at one end of the cable for the U.S.A., Europe and Taiwan versions.

*2 The microphones illustrated at left are the HM-98 and HM-118. One of either the HM-98, HM-97 or HM-118N/TN/TAN microphone is supplied depending on version.

2

PANEL DESCRIPTION

■ Controller unit

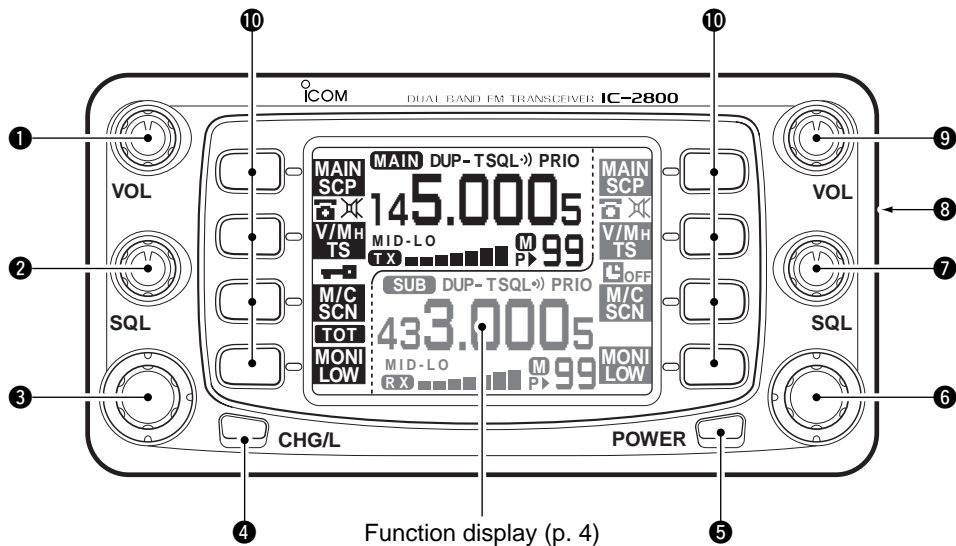

① VHF VOLUME CONTROL [VOL]

Adjusts the VHF audio level. (p. 23)

② VHF SQUELCH CONTROL [SQL]

- ➔ Adjusts the VHF squelch level. (p. 23)
- ➔ Depending on the set mode setting, the RF attenuator is automatically activated when [SQL] is rotated clockwise past the 12 o'clock position. (pgs. 23, 66)

③ VHF TUNING DIAL [DIAL]

Rotate [DIAL] to set operating frequencies, memory channels, set mode contents, etc. (p. 20)

④ CHANGE/LOCK SWITCH [CHG/L]

- ➔ Toggles the multi-function switch menu. (p. 6)
- ➔ Push [CHG/L] for 2 sec. to toggle the lock function ON and OFF. (p. 19)

⑤ POWER SWITCH [POWER]

Push for 2 sec. to toggle the transceiver power ON and OFF. (p. 18)

⑥ UHF TUNING DIAL [DIAL]

Rotate [DIAL] to set operating frequencies, memory channels, set mode contents, etc. (p. 20)

⑦ UHF SQUELCH CONTROL [SQL]

- ➔ Adjusts the UHF squelch level. (p. 23)
- ➔ Depending on the set mode setting, the RF attenuator is automatically activated when [SQL] is rotated clockwise past the 12 o'clock position. (pgs. 23, 66)

⑧ VIDEO INPUT JACK [VIDEO IN]

Inputs an NTSC or PAL video signal depending on version. (p. 73)

⑨ UHF VOLUME CONTROL [VOL]

Adjusts the UHF audio level. (p. 23)

⑩ MULTI-FUNCTION SWITCHES (pgs. 6, 7)

- ➔ Push to select the function indicated in the right-hand or left-hand LCD display of these switches.
- Left-hand switches are used for VHF band and right-hand switches are used for UHF band.
- Functions vary depending on the operating condition.

2 PANEL DESCRIPTION

■ Function display

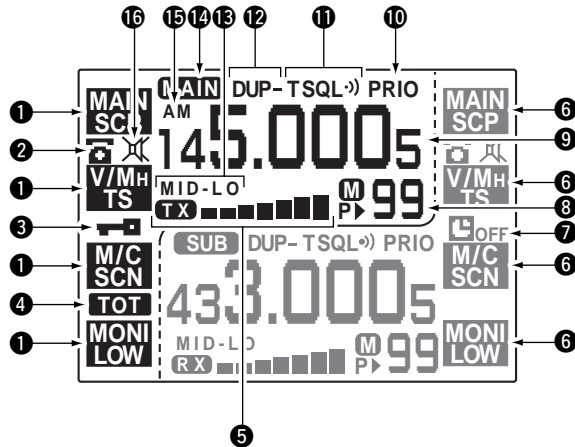

- 1 FUNCTION INDICATORS** (pgs. 6, 7)
Indicate the functions assigned to the multi-function switches at left.
- 2 DTMF MEMORY ENCODER INDICATOR** (p. 54)
Appears when the DTMF memory encoder is in use.
- 3 LOCK INDICATOR** (p. 19)
Appears when the lock function is in use.

- 4 TIME-OUT TIMER INDICATOR** (p. 63)
 - Appears when the time-out timer is activated.
 - Flashes when the time-out time elapses and the transmission is terminated.
- 5 S/R/F INDICATOR**
Shows the relative signal strength while receiving. Shows the relative output power while transmitting. (pgs. 23, 24)
 - “RX” appears when receiving a signal or when the squelch is open.
 - “TX” appears when transmitting.
- 6 FUNCTION INDICATORS** (pgs. 6, 7)
Indicate the functions assigned to the multi-function switches at right.
- 7 AUTO POWER-OFF INDICATOR** (p. 64)
Appears when the auto power-off function is in use.
- 8 MEMORY CHANNEL READOUT**
Shows the memory or call channel number, etc.
 - “M” appears when a memory channel is selected. (p. 18)
 - “P” appears when a selected memory channel is set as a skip channel. (p. 46)
 - “P” appears when the memory channel frequency is set as a skip frequency during scanning. (p. 46)

9 FREQUENCY READOUT

Shows the operating frequency, memory name, etc.

10 PRIORITY WATCH INDICATOR (p. 48)

Appears when priority watch is in use.

11 TONE INDICATORS (pgs. 26, 50, 52)

“T” appears when the subaudible tone encoder is in use; “T SQL •)” appears during pocket beep operation and “T SQL” appears when the tone squelch function is activated.

12 DUPLEX INDICATORS (p. 26)

Appear when semi-duplex operation (repeater operation) is in use.

- “DUP-” appears when minus duplex is selected; “DUP” appears when plus duplex is selected.

13 OUTPUT POWER INDICATORS (p. 25)

- ↳ “HI” appears when high output power is selected.
- ↳ “MID-HI” appears when mid high output power is selected
- ↳ “MID-LO” appears when mid low output power is selected
- ↳ “LO” appears when low output power is selected

14 MAIN BAND INDICATOR (p. 18)

- ↳ “**MAIN**” appears above the frequency which is selected as the main band.
- ↳ “**SUB**” appears when the sub band access function is in use.
 - This function can be used via the HM-98 and HM-90.

15 AM/FM NARROW MODE INDICATOR (p. 74)

- ↳ “AM” appears when AM mode is selected.
 - AM mode is available for the U.S.A. and S. America versions only.
- ↳ “NAR” appears when FM narrow mode is selected.
 - FM narrow mode is available for the VHF band of the Europe version only.

16 MUTE INDICATOR (pgs. 24, 65)

- ↳ Both band’s indicators appear when the mute function is in use.
 - This function can be used via the HM-98 and HM-90.
- ↳ Sub band’s indicator appears when the sub band mute function is activated.

2 PANEL DESCRIPTION

■ Basic function menu

The multi-function switches have 2 main menus. Pushing [CHG/L] toggles between the 2 multi-function switch menus.

Left-hand switches are used for VHF band and right-hand switches are used for UHF band except ⑧ and ⑨.

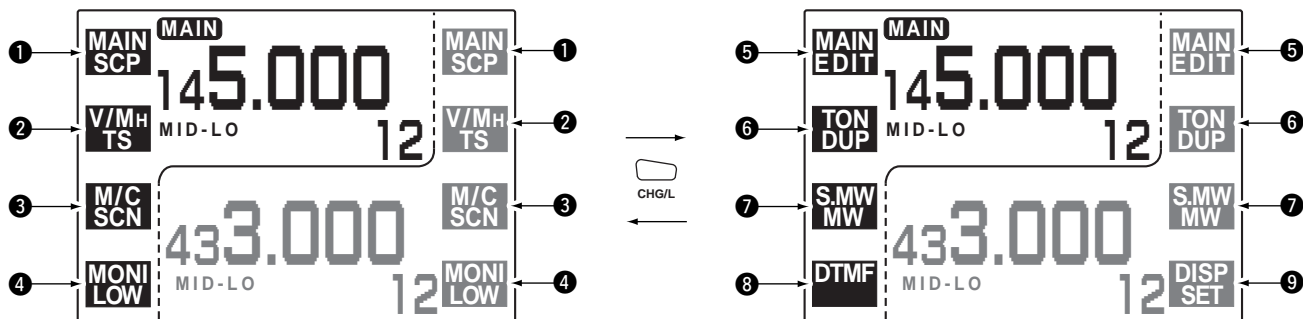

① MAIN BAND/BAND SCOPE MENU [MAIN (SCP)]

- ➔ Push to select the main band. (p. 18)
- ➔ Push for 2 sec. to enter the band scope screen. (p. 47)

② VFO/MHz/TUNING STEP MENU [V/MH (TS)]

- ➔ Push to select VFO mode or to select the MHz tuning step while in VFO mode. (p. 20)
- ➔ Push for 2 sec. to enter tuning step screen. (p. 21)

③ MEMORY CHANNEL/CALL CHANNEL/SCAN MENU [M/C (SCN)]

- ➔ Push to select the memory mode or call channel. (pgs. 18, 38)
- ➔ Push for 2 sec. to enter the scan screen. (p. 42)

4 MONITOR/LOW POWER MENU [MONI(LOW)]

- ➔ Push to toggle the monitor function ON and OFF. (p. 24)
- ➔ Push for 2 sec. to change the output power selection. (p. 25)
 - Low (LO), mid-low (MID-LO), mid-high (MID-HI) and high (HI) powers are available.

5 MAIN BAND/MEMORY EDIT MENU [MAIN(EDIT)]

- ➔ Push to select the main band. (p. 18)
- ➔ Push for 2 sec. to enter the edit screen. (pgs. 29, 30, 37, 46, 51)

6 TONE/DUPLEX MENU [TON(DUP)]

- ➔ Push to activate the following functions in order.
 - Subaudible tone encoder—"T" appears. (p. 26)
 - Pocket beep—"T SQL·)" appears. (p. 52)
 - Tone squelch—"T SQL" appears. (p. 50)
 - No tone operation—no indicator appears.
- ➔ Push for 2 sec. to select semi-duplex or simplex operation. (p. 26)
 - "DUP-" appears during minus duplex operation, "DUP" appears during plus duplex operation and no indicator appears during simplex operation.

7 SELECT MEMORY WRITE/MEMORY WRITE MENU [S.MW(MW)]

- ➔ Push to select the desired memory channel number to be programmed. (p. 32)
- ➔ Push for 2 sec. to program a memory channel or call channel while in VFO mode. (p. 32)
- ➔ Push for 2 sec. to transfer a memory channel, call channel or scratch pad memory contents into the VFO when not in VFO mode. (p. 33)

8 DTMF MENU [DTMF]

- ➔ Push to toggle the DTMF memory ON and OFF. (p. 55)
- ➔ Push for 2 sec. to enter the DTMF memory screen. (p. 54)

9 DISPLAY/SET MODE MENU [DISP(SET)]

- ➔ Push to enter the display set mode screen. (p. 68)
- ➔ Push for 2 sec. to enter the set mode screen.

2 PANEL DESCRIPTION

■ Main unit

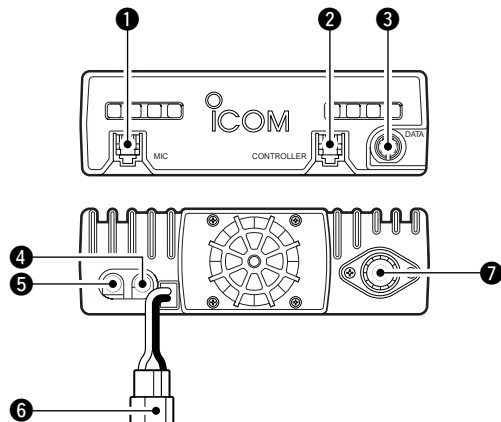

① MICROPHONE CONNECTOR [MIC]

Connects the supplied microphone.

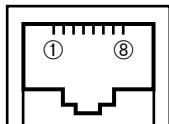

- ① +8 V DC output (Max. 10 mA)
- ② Frequency up/down
- ③ HM-90/98 control input
- ④ PTT
- ⑤ Microphone ground
- ⑥ Microphone input
- ⑦ Ground
- ⑧ No connection

② CONTROLLER CONNECTOR [CONTROLLER] (p. 16)

Connects the controller unit with the supplied cable.

③ DATA CONNECTOR [DATA] (p. 70)

Connects a TNC (Terminal Node Controller), etc. for data communications.

•See the information at right for details.

④ 144 MHz SPEAKER CONNECTOR [144 MHz SP]

Connects an 8 Ω speaker, if desired.

⑤ 430(440) MHz SPEAKER CONNECTOR [430(440) MHz SP]

Connects an 8 Ω speaker, if desired.

Connected speaker	VHF band audio	UHF band audio
With no external speakers	Internal speaker (mixed audio)	
[144MHz SP] only	External speaker (mixed audio)	
[430(440) MHz SP] only	Internal speaker	External speaker
2 external speakers	External speaker via [144MHz SP]	External speaker via [430(440) MHz SP]

6 POWER RECEPTACLE [DC13.8V] (pgs. 15, 16)

Accepts 13.8 V DC $\pm 15\%$ with the supplied DC power cable.

- Current of 12 A or greater is required.

DO NOT use a cigarette lighter socket as a power source when operating in a vehicle. The plug may cause voltage drops and ignition noise may be superimposed onto transmit or receive audio.

7 ANTENNA CONNECTOR [ANT]

Connects a 50 Ω antenna with a PL-259 connector and a 50 Ω coaxial cable.

ANTENNA INFORMATION

For radio communications, the antenna is of critical importance, along with output power and sensitivity. The transceiver accepts a 50 Ω antenna and less than 1.5 : 1 of Voltage Standing Wave Ratio (VSWR). High SWR values not only may damage the transceiver but also lead to TVI or BCI problems.

◆ DATA JACK PIN ASSIGNMENTS

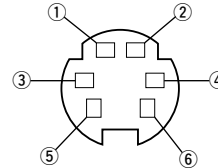

- ① DATA IN (1200 bps: AFSK
9600 bps: G3RUH, GMSK)
- ② GND
- ③ PTT P
- ④ DATA OUT (9600 bps)
- ⑤ AF OUT (1200 bps)
- ⑥ P SQL

① DATA IN

Input terminal for data transmit. See p. 70 for details on how to toggle data speed between 1200 and 9600 bps.

② GND

Common ground for DATA IN, DATA OUT and AF OUT.

③ PTT P

PTT terminal for packet operation only. Connect ground to transmit data.

④ DATA OUT

Data out terminal for 9600 bps operation only.

⑤ AF OUT

Data out terminal for 1200 bps operation only.

⑥ P SQL (squelch out)

Becomes high (+5V) when the transceiver receives a signal which opens the squelch.

- To avoid unnecessary TNC transmission, connect squelch to the TNC to inhibit transmission when receiving signals.
- Keep audio output at a normal level, otherwise a "P SQL" signal will not be output.

2 PANEL DESCRIPTION

■ HM-98 microphone*

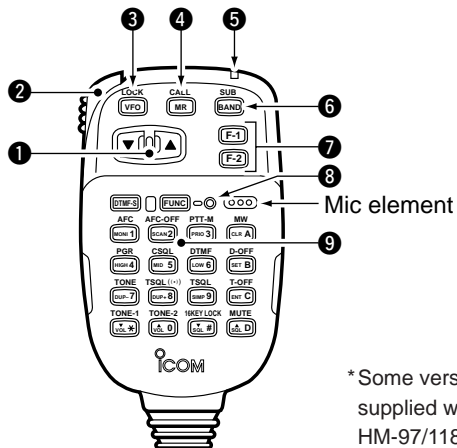

*Some versions are supplied with the HM-97/118 instead.

1 UP/DOWN SWITCHES [▲]/[▼]

- ➔ Push either switch to change the operating frequency, memory channel, set mode contents, etc. (p. 20)
- ➔ Push either switch for 2 sec. to start scanning. (p. 43)

2 PTT SWITCH

- ➔ Push and hold to transmit; release to receive. (p. 24)
- ➔ Toggles between transmitting and receiving while the one-touch PTT function is in use. (p. 25)

3 VFO SWITCH [VFO(LOCK)]

- ➔ Push to select VFO mode. (p. 18)
- ➔ Push for 2 sec. to toggle the lock function. (p. 19)

4 MEMORY SWITCH [MR(CALL)]

- ➔ Push to select memory mode.
- ➔ Push for 2 sec. to select the call channel. (p. 38)

5 ACTIVITY INDICATOR

Lights red while a key is pushed; lights green while the one-touch PTT function is in use.

6 BAND SWITCH [BAND(SUB)] (p.18)

- ➔ Push to toggle the operating band or set the sub band as the main band.
- ➔ Push for 2 sec. to toggle the sub band access function.

7 FUNCTION SWITCHES [F-1]/[F-2] (p.67)

Assign your desired key function from the front panel switches.













- Default settings are [VHF M/C] for [F-1] and [UHF M/C] for [F-2].

8 FUNCTION INDICATOR









- ➔ Lights orange while [FUNC] is activated—indicates the secondary function of switches can be accessed.
- ➔ Lights green when [DTMF-S] is activated—DTMF signals can be transmitted with the keypad. (p. 55)

9 KEYPAD

Used for controlling the transceiver, transmitting DTMF signals, etc. See the following 2 pages for details.

KEY	FUNCTION	SECONDARY FUNCTION (after )	OTHER FUNCTIONS
	Toggles between opening and closing the operating band's squelch. (p. 24)	No secondary function.	After  : Transmit the appropriate DTMF code or push [0] to [9], [A] to [D] to transmit the DTMF memory contents when the DTMF memory encoder is activated. (p. 54)
	Starts and stops scanning. (p. 42)	No secondary function.	
	Starts and stops priority watch. (p. 48)	Turns the one-touch PTT function ON and OFF. (p. 25)	
	Selects high output power. (p. 25)	No secondary function.	
	Selects mid-high output power. (p. 25)	No secondary function.	
	Selects low output power. (p. 25)	Turns the DTMF memory encoder function ON. (p. 54)	
	Selects –duplex. (p. 27)	Turns the subaudible tone encoder ON. (p. 27)	
	Selects +duplex. (p. 27)	Turns the pocket beep function ON. (p. 52)	
	Selects simplex. (p. 27)	Turns the tone squelch function ON. (p. 50)	
	Increases the audio output. (p. 23) •The [VOL] controls on the controller unit have priority when rotated.	While being pushed, transmits a 1750 Hz tone. (p. 28)	

2 PANEL DESCRIPTION

KEY	FUNCTION	SECONDARY FUNCTION (after )	OTHER FUNCTIONS
	<ul style="list-style-type: none"> •Clears a digit before entry. (p. 22) •Cancels the monitor, scan, priority watch, DTMF memory, mute function or set mode condition. (pgs. 24, 42, 48, 54) 	<ul style="list-style-type: none"> •Writes the VFO contents into the memory channel or call channel. (pgs. 34, 39) •Advances the memory channel number when continuously pushed after programming is completed. (p. 34) 	After  : Transmit the appropriate DTMF code or push [0] to [9], [A] to [D] to transmit the DTMF memory contents when the DTMF memory encoder is activated. (p. 54)
	Enters set mode and decreases the set mode selection order.	DTMF memory OFF.	
	<ul style="list-style-type: none"> •Sets the keypad for numeral input. (p. 22) •Advances the set mode selection order after entering set mode. 	Turns the subaudible tone encoder, pocket beep or tone squelch OFF. (pgs. 27, 50, 52)	
	Increases the squelch level. (p. 23) <ul style="list-style-type: none"> •The [SQL] controls on the controller unit have priority when rotated. 	Mutes both band's audio. (p. 24) <ul style="list-style-type: none"> •Mute function is released when any operation is performed. 	
	Decreases the squelch level. (p. 23) <ul style="list-style-type: none"> •The [SQL] controls on the controller unit have priority when rotated. 	Locks the digit keys on the keypad (including the A–D, # and * keys). (p. 19)	
	Decreases the audio output. (p. 23) <ul style="list-style-type: none"> •The [VOL] controls on the controller unit have priority when rotated. 	Sends a 1750 Hz tone signal for 0.5 sec. (p. 28)	After  : Transmit the appropriate DTMF code. (p. 54)

■ HM-97/118N microphone

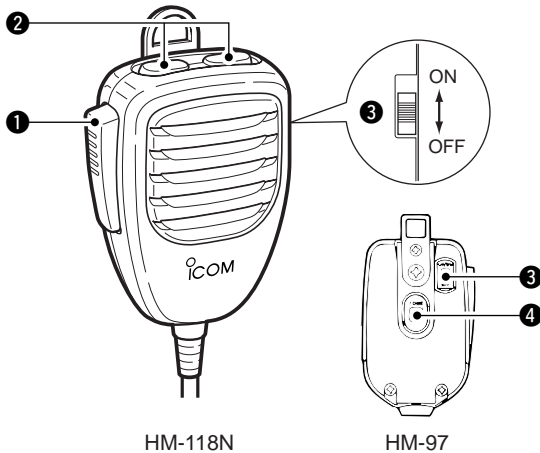

HM-118N

HM-97

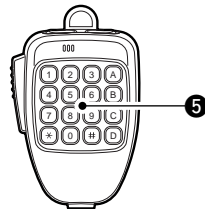

HM-118TN/TAN

① PTT SWITCH

Push and hold to transmit; release to receive. (p. 24)

② UP/DOWN SWITCHES [UP]/[DN]

- ➔ Push either switch to change the operating frequency, memory channel, set mode contents, etc. (p. 20)
- ➔ Push either switch for 2 sec. to start scanning. (p. 42)
- ➔ Activate a function programmed in set mode. (p. 68)

③ LOCK SWITCH

Locks the [UP]/[DN] keys on the microphone.

④ TONE SWITCH (HM-97 only)

Push to transmit a 1750 Hz tone call signal. (p. 28)

⑤ DTMF KEYPAD (HM-118TN/TAN only)

Used for transmitting DTMF signals.

Location

Select a location which can support the weight of the transceiver and does not interfere with driving in any way. We recommend the locations shown in the diagram below.

NEVER place the transceiver or remote controller where normal operation of the vehicle may be hindered or where it could cause bodily injury.

NEVER place the transceiver or remote controller where air bag deployment may be obstructed.

DO NOT place the transceiver or remote controller where hot or cold air blows directly onto it.

AVOID placing the transceiver or remote controller in direct sunlight.

EXAMPLE INSTALLATION LOCATIONS

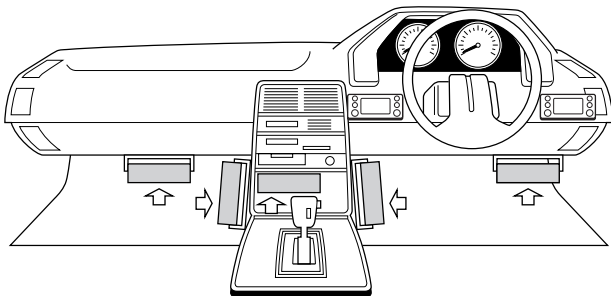

Mounting with the mounting bracket

- ① Drill 4 holes where the mounting bracket is to be installed.
 - Approx. 5.5–6 mm ($\frac{3}{16}$ ") when using nuts; approx. 2–3 mm ($\frac{1}{16}$ ") when using self-tapping screws.
- ② Insert the supplied screws, nuts and washers through the mounting bracket and tighten.
- ③ Adjust the angle, if desired.

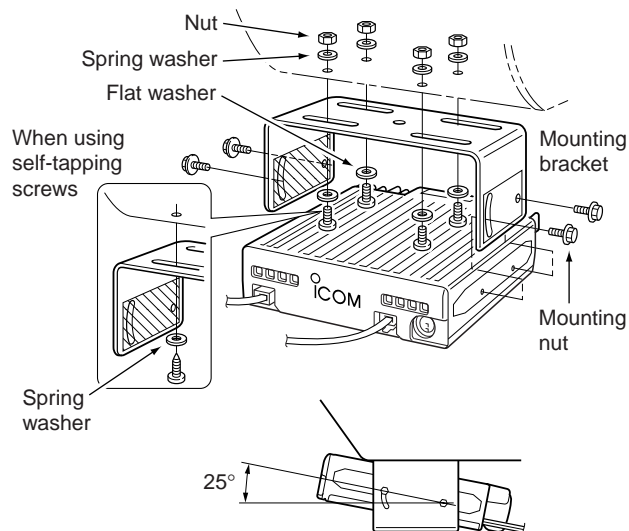

■ Mounting the remote controller

Install the nut before attaching the bracket to the wall, etc.

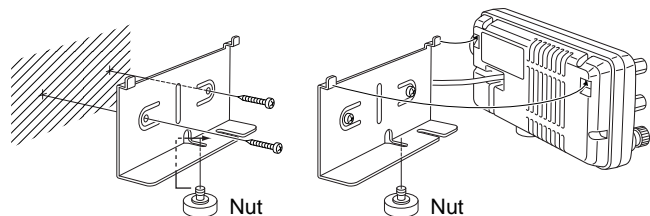

◇ When using an optional MB-65

The supplied remote controller bracket is not necessary when using the optional MB-65.

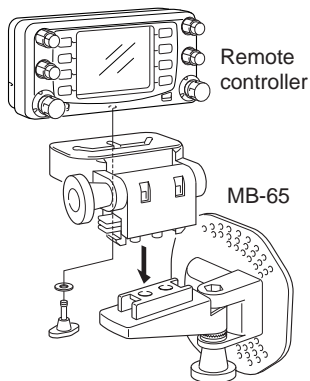

■ Battery connection

NEVER connect the transceiver directly to a 24 V battery.
DO NOT use the cigarette lighter socket for power connections.

Attach a rubber grommet when passing the DC power cable through a metal plate to prevent short circuits.

• See p. 74 for fuse replacement.

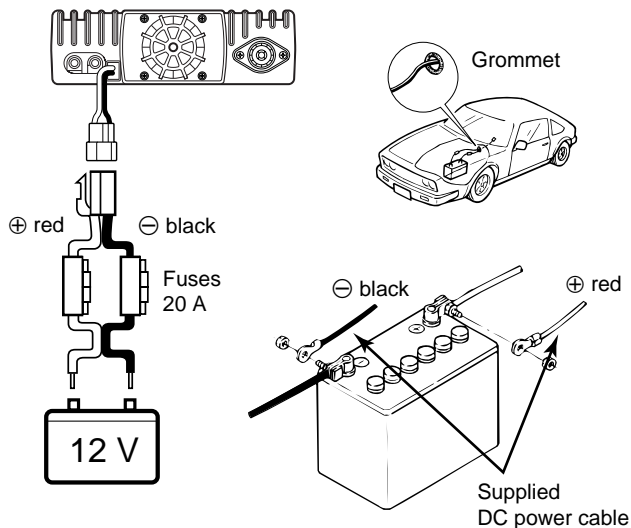

3 INSTALLATION

■ DC power supply connection

Use a 13.8 V DC power supply with more than 12 A capacity.

Make sure the ground terminal of the DC power supply is grounded.

- See p. 74 for fuse replacement.

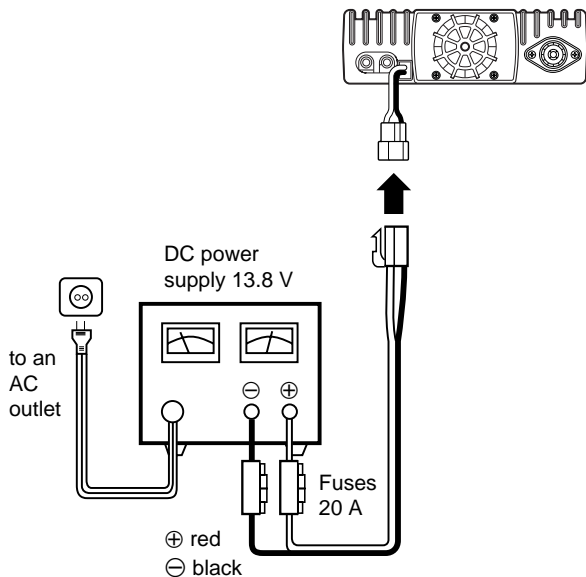

■ Cable connection

Connect the cable as shown below.

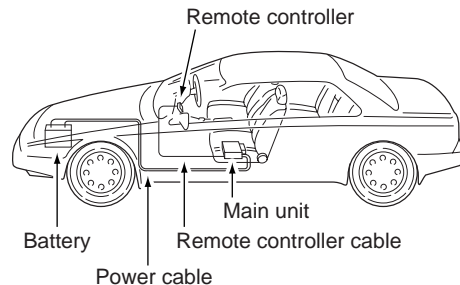
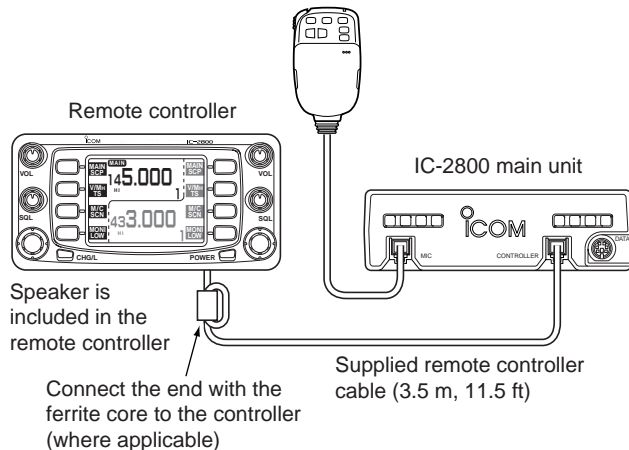

■ Antenna installation

◇ Antenna location

To obtain maximum performance from the transceiver, select a high-quality antenna and mount it in a good location. A non-radial antenna should be used when using a magnetic mount.

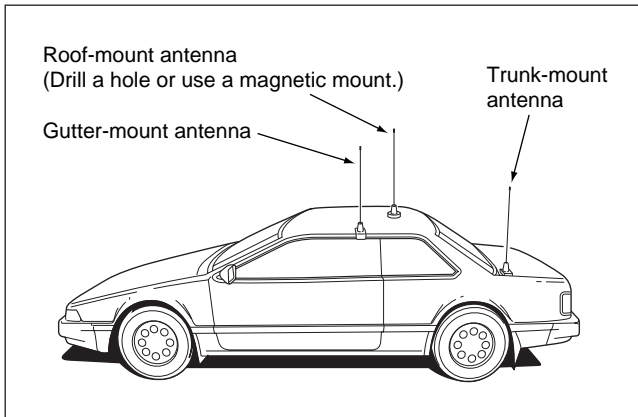

◇ Antenna connector

The antenna uses a PL-259 connector.

•PL-259 CONNECTOR

- ① Slide the coupling ring down. Strip the cable jacket and soft solder.

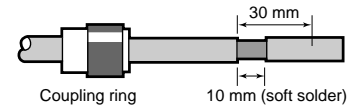

- ② Strip the cable as shown at right. Soft solder the center conductor.

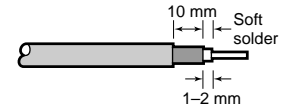

- ③ Slide the connector body on and solder it.

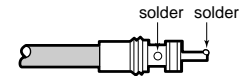

- ④ Screw the coupling ring onto the connector body.

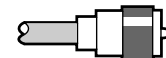

(10 mm \approx 3/8 in)

4

FREQUENCY SETTING

■ Preparation

◇ Turning power ON/OFF

Before operating the transceiver for the first time it's a good idea to reset the transceiver's CPU. This will ensure that all transceiver settings are at their defaults. See p. 75 for CPU resetting details.

➔ Push [POWER] for 2 sec. to turn power ON or OFF.

◇ Operating band

The transceiver can receive 144 MHz and 430(440) MHz band signals simultaneously. To activate all functions or to change frequency via the microphone, you must designate one band as the main band. The transceiver can transmit a signal on the main band only.

➔ Push either [MAIN] to select the desired transmit band.
• "[MAIN]" indicator shows the selected band as the main band.

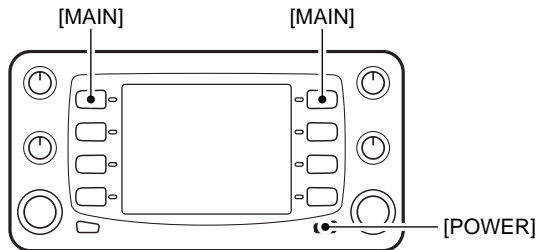

➔ Push [BAND] to select the desired operating band.
• "[MAIN]" indicator shows the selected band as the main band.

◇ VFO and memory modes

The transceiver has 2 basic operating modes: VFO mode and memory mode. Select VFO mode first to set an operating frequency.

➔ Push [V/MHz] to select VFO mode when the transceiver is not in VFO mode.

• If VFO mode is already selected, the digits below 100* kHz disappear. In this case, push [V/MHz] again (or push twice or 3 times depending on version).

* The digits below 1 or 10 MHz disappear for some versions.



"M" appears in memory mode.



➔ Push [VFO] to select VFO mode.
➔ Push [MR] to select memory mode.



Note that in this manual, sections beginning with a microphone icon (as above), designate operation via the HM-98 microphone.

■ Lock functions

To prevent accidental frequency changes and unnecessary function access, use the lock function. The transceiver and HM-98 have 2 different lock functions.

◇ Frequency lock

This function locks the tuning dials and switches electronically and also locks the microphone switches.

- ➔ Push [CHG/L] for 2 sec. to toggle the frequency lock function ON and OFF.
 - [CHG/L], [MAIN], [MONI], [VOL], [SQL], [PTT] and [BAND] can be used while the frequency lock function is in use. Also, TONE-1, TONE-2, DTMF tones or DTMF memory contents can be transmitted from the HM-98 microphone.

- ➔ Push [(VFO)LOCK] for 2 sec. to toggle the function ON and OFF.

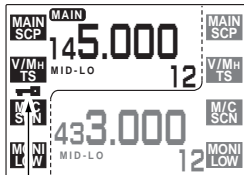

“” appears when the lock function is in use.

◇ Microphone keypad lock

This function locks the HM-98 microphone keypad.



- ➔ Push [FUNC] then [16KEYLOCK] to toggle the microphone keypad lock function ON and OFF.
 - [PTT] and the 7 keys on the upper half of the microphone can be used.
 - All switches on the transceiver can be used.
 - The keypad lock function is released when the transceiver power is turned OFF then ON again.

4 FREQUENCY SETTING

■ Using the tuning dial

- ① Select VFO mode with the desired band's [V/MHz].
 - Push [CHG/L] if [V/MHz] is not displayed.
- ② Rotate desired band's [DIAL] to change the frequency.
 - The frequency changes according to the selected tuning steps.
See the next page for selecting the tuning step.

◇ 1 MHz tuning step

Push the selected band's [V/MHz] to select 1 MHz tuning step.
Push [V/MHz] again to return to the previous tuning step.

◇ 10 MHz and 1 MHz tuning steps

Push the selected band's [V/MHz] once or twice to select 10 MHz or 1 MHz tuning step, respectively. Push [V/MHz] once or twice to return to the previous tuning step.

Some versions do not have the 10 MHz tuning step.

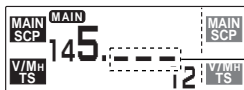

While 1 MHz tuning step is selected, the digits below 100 kHz disappear.

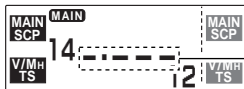

While 10 MHz tuning step is selected, the digits below 1 MHz disappear.

■ Using the [▲]/[▼] keys



- ① Push [BAND] to select the desired band.
- ② Push [VFO] to select the VFO mode.
- ③ Push [▲] or [▼] to select the desired frequency.
 - The frequency changes according to the selected tuning steps. (p. 21)
 - Pushing [▲] or [▼] for more than 0.5 sec. activates a scan. If this happens, push [▲] or [▼] again to cancel the scan.

/// 1 MHz or 10 MHz steps cannot be used via the [▲]/[▼] keys.

■ Setting a tuning step

Tuning steps can be selected for each band. This transceiver has 8 tuning steps as follows:

- 5 kHz •10 kHz •12.5 kHz •15 kHz •20 kHz
- 25 kHz •30 kHz •50 kHz

- ① Select VFO mode with the desired band's [V/MHz].
 - Push [CHG/L] if [V/MHz] is not displayed.
- ② Push [(V/MHz)TS] for 2 sec. to enter tuning step screen.
- ③ Rotate desired band's [DIAL] to select the desired tuning step.
 - Pushing [5], [20] or [25] also selects 5, 20 or 25 kHz tuning step.
- ④ Push [↶] to return to normal operation.

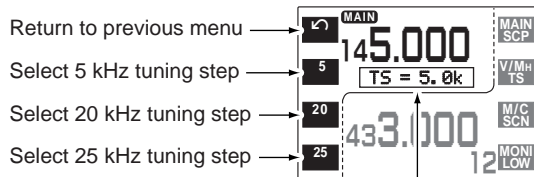

Shows 5 kHz tuning step is selected.

•Cloning mode information

The information in the transceiver, such as memory channels, memory names, etc. can be programmed using a PC. The transceiver displays the following information when the transceiver enters cloning mode for programming.

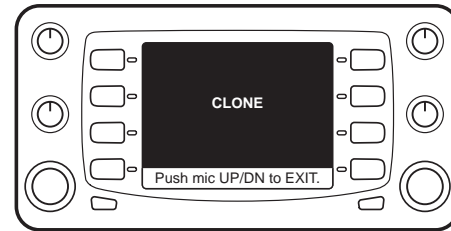

In the cloning mode, the [POWER] switch does not function. Push the [UP]/[DN] or [▲]/[▼] on the microphone to return to the normal operating condition.

4 FREQUENCY SETTING

■ Using the keypad



The frequency can be directly set via numeral keys on the HM-98 microphone.

- ① Push [BAND] to select the desired operating band.
- ② Push [VFO] to select VFO mode, if necessary.
- ③ Push [ENT] to activate the keypad for digit input.
- ④ Push 6 keys to input a frequency.
 - When a digit is mistakenly input, push [ENT] to clear the input, then repeat input from the 1st digit.
 - Pushing [CLR] clears input digits and retrieves the frequency.
- ⑤ Push [▲] or [▼] to make adjustments below the 10 kHz digit, if desired.

[EXAMPLE]: Setting the frequency to 145.3625 MHz.

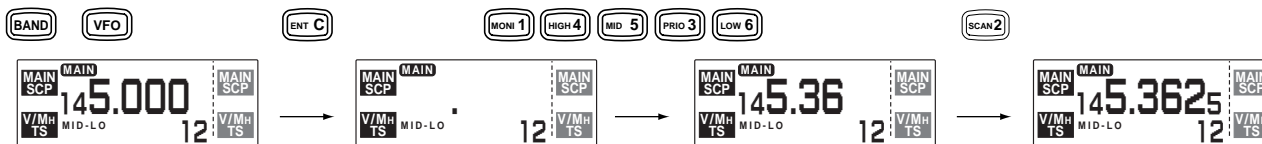

■ Receiving

- ① Push [POWER] for 2 sec. to turn power ON.
- ② Set the audio level.
 - ➔ Push the desired band's [MONI] to open the squelch.
 - Push [CHG/L] if [MONI] is not displayed.
 - ➔ Rotate the desired band's [VOL] control to adjust the audio output level.
 - ➔ Push [MONI] again to close the squelch.
- ③ Set the squelch level.
 - ➔ Rotate the desired band's [SQL] fully counterclockwise in advance.
 - ➔ Rotate [SQL] clockwise until the noise just disappears.
 - ➔ When interference is received, rotate [SQL] clockwise again for attenuator operation.
 - Turn the automatic RF attenuator ON in advance. (p. 66)
- ④ Set the operating frequency. (p. 20)
- ⑤ When receiving a signal on the set frequency, squelch opens and the transceiver emits audio.
 - "RX" appears and the S/R/F indicator shows the relative signal strength for the received signal.



- ① Push [POWER] for 2 sec. to turn power ON.
- ② Select the desired band with [BAND].
- ③ Set the audio level.
 - ➔ Push [① MONI] to open the squelch.
 - ➔ Push [VOL ▲] or [VOL ▼] to adjust the audio output level.



- Volume level appears while setting.
- ➔ Push [① MONI] again to close the squelch.
 - ④ Set the squelch level.
 - ➔ Push [SQL ▲] or [SQL ▼] to set the squelch to the point where noise just disappears.
 - Squelch level appears while setting.
 - ⑤ Set the operating frequency. (p. 22)
 - ⑥ When receiving a signal on the set frequency, squelch opens and the transceiver emits audio.
 - "RX" appears and the S/R/F indicator shows the relative signal strength for the received signal.

RF attenuator: The transceiver has an RF attenuator related to the [SQL] setting. The attenuator is automatically activated when [SQL] is rotated clockwise past the 12 o'clock position. Approx. 10 dB attenuation is obtained at full rotation. Turn the automatic RF attenuator ON in advance in set mode. (p. 66)

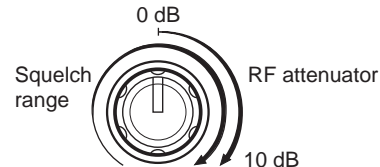

5 BASIC OPERATION

■ Monitor function

This function is used to listen to weak signals without disturbing the squelch setting or to open the squelch manually even when mute functions such as the tone squelch are in use.

➔ Push the desired band's [MONI] to toggle the monitor function ON and OFF.

- While duplex is ON for repeater operation, the transmitting frequency can be monitored with [MONI].



Push [① MONI] to toggle the monitor function ON and OFF.

■ Audio mute function

This function temporarily mutes the audio without disturbing the volume setting.



- ① Push [FUNC] then [Ⓣ MUTE] to mute audio signals.
 - "X" appears.
- ② Push [Ⓜ CLR] (or any other key) to cancel the function.
 - "X" disappears.

■ Transmitting

CAUTION: Transmitting without an antenna may damage the transceiver.





To prevent interference, listen on the frequency before transmitting by pushing [MONI] or [① MONI] on the HM-98 microphone.

- ① Select the desired band with the desired band's [MAIN] or [BAND] on the HM-98 microphone.
- ② Set the operating frequency.
 - Select output power if desired. See the next section for details.
- ③ Push and hold [PTT] to transmit.
 - "TX" appears.
 - The S/Rf indicator shows the output power selection.
 - The operating frequency, etc. is automatically programmed into a scratch pad memory. See p. 40 for details.
 - A one-touch PTT function is available. See p. 25 for details.
- ④ Speak into the microphone using your normal voice level.
 - **DO NOT** hold the microphone too close to your mouth or speak too loudly. This may distort the signal.
- ⑤ Release [PTT] to return to receive.

■ Selecting output power

The transceiver has 4 output power levels to suit your operating requirements. Low output powers during short-distance communications may reduce the possibility of interference to other stations and will reduce current consumption.

- ➔ Push the desired band's [(MONI)LOW] for 2 sec. one or more times to select the output power.
 - Push [CHG/L] if [(MONI)LOW] is not displayed.
 - The output power can be changed while transmitting.

Power selection	S/R/F indicator	Output power		Taiwan version only
		VHF	UHF	
LOW		5 W	5 W	5 W
MID LOW		10 W	10 W	10 W
MID HIGH		20 W	20 W	15 W
HIGH		50 W	35 W	25 W

The microphone can also be used to select output power.



- ① Push [BAND] to select the desired band.
- ② Push [④HIGH] for high output power; [⑤MID] for mid-high output power; and [⑥LOW] for low output power.
 - The output power **CANNOT** be changed via the microphone while transmitting.

■ One-touch PTT function

The PTT switch can be operated as a one-touch PTT switch (each push toggles transmit/receive). Using this function you can transmit without pushing and holding the PTT switch.

To prevent accidental, continuous transmissions with this function, the transceiver has a time-out timer. See p. 63 for details.



- ① Push [FUNC] then [③PTT-M] to turn the one-touch PTT function ON.
 - The activity indicator lights green.
- ② Push [PTT] to transmit and push again to receive.
 - Two beeps sound when transmission is started and a long beep sounds when returning to receive.
 - "TX" flashes when transmitting with the one-touch PTT function.
- ③ Push [FUNC] then [③PTT-M] to turn the one-touch PTT function OFF.
 - The activity indicator goes out.

■ Accessing a repeater

When using a repeater, the transmit frequency is shifted from the receive frequency by the offset frequency. (p. 30) It is convenient to program repeater information into memory channels. (p. 32)

- ① Select the desired band with the desired band's [MAIN].
- ② Set the receive frequency (repeater output frequency). (pgs. 20)
- ③ Push the desired band's [(TON)DUP] for 2 sec., one or more times, to select minus duplex or plus duplex.
 - Push [CHG/L] if [(TON)DUP] is not displayed.
 - "DUP-" or "DUP" appears to indicate the transmit frequency for minus shift or plus shift, respectively.
 - When the auto repeater function is in use (U.S.A. and Korea versions only), this selection and step ④ are not necessary. (p. 31)

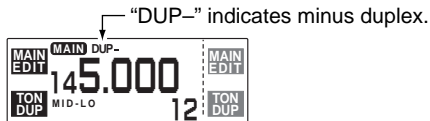

- ④ Push the desired band's [TON] one or more times to turn ON the subaudible tone encoder, according to repeater requirements.
 - Refer to p. 29 for tone frequency settings.
 - When the repeater requires a different tone system, see the next page.

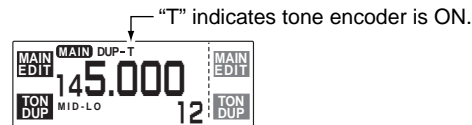

- ⑤ Push and hold [PTT] to transmit.
 - The displayed frequency automatically changes to the transmit frequency (repeater input frequency).
 - The operating condition is automatically programmed into a scratch pad memory. See p. 40 for details.
 - If "OFF" appears, check the offset frequency. (p. 30)
- ⑥ Release [PTT] to receive.
- ⑦ Push [MONI] to check whether the other station's transmit signal can be received directly.
 - Push [CHG/L] if [MONI] is not displayed.
- ⑧ To return to simplex operation, push [(TON)DUP] for 2 sec., once or twice, to clear the "DUP" indicator.
- ⑨ To turn OFF the subaudible tone encoder, push [TON] one or more times until no tone indicators appear.



DUP-
7

① Select the desired band with [BAND].
② Set the receive frequency (repeater output frequency).

DUP+
8

③ Push [⑦ DUP-] to select -duplex; push [⑧ DUP+] for +duplex.
④ Push [FUNC] then [⑦ TONE] to turn ON the subaudible tone encoder according to repeater requirements.

SIMP
9

- Refer to p. 29 for tone frequency setting.
- When the repeater requires a different tone system, see p. 29.

⑤ Push and hold [PTT] to transmit.
⑥ Push [① MONI] to check whether the other station's signal can be received directly.
⑦ Release [PTT] to receive.
⑧ To return to simplex operation, push [⑨ SIMP].
⑨ To turn OFF the subaudible tone encoder, push [FUNC], then [© T-OFF].

◀ CONVENIENT

Tone scan function: When you don't know the subaudible tone used for a repeater, the tone scan is convenient for detecting the tone frequency.

- ① Push the desired band's [(M/C)SCN] for 2 sec. to enter scan screen.
 - Push [CHG/L] if [(M/C)SCN] is not displayed.
- ② Push [TON] to start tone scan. Push [↶] for 2 sec. to exit scan screen. See p. 53 for more information.

◇ DTMF tones

DTMF-S

- ① Push [BAND] to select the desired band.
- ② Push [DTMF-S], then push the keys of the desired DTMF digits.
 - The function indicator lights green.
 - 0-9, A-D, *(E) and #(F) are available.
 - Cancel the DTMF memory encoder in advance, if necessary. (p. 54)
 - Push [DTMF-S] again to return the keypad to normal function control.
 - The transceiver has 14 DTMF memory channels (D0-D9, DA-DD) for auto patch operation. (p. 54)

6 REPEATER OPERATION

■ 1750 Hz tone

A 1750 Hz tone is required to access most European repeaters. The microphone has 1750 Hz tone capability.

◇ Using the HM-98 microphone



① Push [BAND] to select the desired band.

② Push [FUNC].

• The mode indicator lights orange.

③ Push [⊕ TONE-1] to transmit a 1750 Hz tone call signal for 0.5 sec.; push and hold [⓪ TONE-2] to transmit a 1750 Hz tone call signal for an arbitrary period.

• The mode indicator goes out automatically.

• The optional HM-90 also has 1750 Hz tone capability.



◇ Using the HM-97 microphone

➔ Push [TONE] on the microphone rear panel to transmit a 1750 Hz tone.

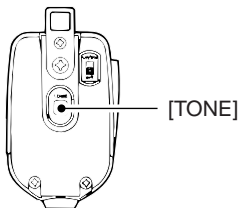

■ Subaudible tone (encoder function)

Some repeaters require subaudible tones to be accessed. Subaudible tones are superimposed over your normal signal and must be set in advance.

Each operating band and each memory channel have independent settings.

- ① Select the mode/channel you wish to set the subaudible tone encoder frequency to, such as VFO mode or memory/call channel.
 - Push [CHG/L] if [(MAIN)EDIT] is not displayed.
- ② Push the desired band's [(MAIN)EDIT] for 2 sec. to enter the edit screen.
 - Push [CHG/L] if [(MAIN)EDIT] is not displayed.
- ③ Push [▲] or [▼] to select the 'R-Tone' item.
 - Left-hand tuning dial can also select the item.

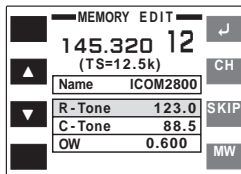

- ④ Rotate the right-hand tuning dial to select the desired frequency.
 - The subaudible tone encoder frequency is set temporarily. Push [MW] for 2 sec. to store the tone frequency permanently.
 - The color of the frequency indication changes when the setting is different from the memory or call channel contents.
- ⑤ If you want to set other channels, push [CH] then rotate the right-hand tuning dial. Repeat ③ and ④ to select the desired frequency.
- ⑥ Push [↵] to exit the edit screen.

▨ The subaudible tone encoder frequency can be set in a memory channel temporarily. However, the set contents are cleared once the other memory/call channel is selected. To store the tone frequency permanently, push [MW] for 2 sec. at step ④ to overwrite the information.

• Available subaudible tone frequencies (unit: Hz)

67.0	82.5	100.0	123.0	151.4	171.3	189.9	210.7	250.3
69.3	85.4	103.5	127.3	156.7	173.8	192.8	218.1	254.1
71.9	88.5	107.2	131.8	159.8	177.3	196.6	225.7	
74.4	91.5	110.9	136.5	162.2	179.9	199.5	229.1	
77.0	94.8	114.8	141.3	165.5	183.5	203.5	233.6	
79.7	97.4	118.8	146.2	167.9	186.2	206.5	241.8	

6 REPEATER OPERATION

■ Offset frequency

When communicating through a repeater, the transmit frequency is shifted from the receive frequency by an amount determined by the offset frequency.

- ① Select the mode/channel you wish to set the offset frequency to, such as VFO mode or memory/channel.
- ② Push the desired band's [(MAIN)EDIT] for 2 sec. to enter the edit screen.
 - Push [CHG/L] if [(MAIN)EDIT] is not displayed.
- ③ Push [▲] or [▼] to select the 'OW' item.
 - Left-hand tuning dial can also select the item.

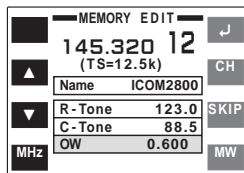

- ④ Rotate the right-hand tuning dial to select the desired frequency.
 - The offset frequency is set temporarily. Push [MW] for 2 sec. to store the offset frequency permanently.
 - Push [MHz] to toggle the 1 MHz tuning step ON and OFF.
 - The color of the frequency indication changes when the setting is different from the memory or call channel contents.

- ⑤ If you want to set other channels, push [CH] then rotate the right-hand tuning dial. Repeat ③ and ④ to select the desired frequency.
- ⑥ Push [↵] to exit the edit screen.

■ Auto repeater function

(U.S.A. and Korea versions only)

The U.S.A. and Korea versions automatically activate the repeater settings (duplex ON/OFF, duplex direction, tone encoder ON/OFF) when the operating frequency falls within or outside of the general repeater output frequency range. The offset and repeater tone frequencies are not changed by the auto repeater function, reset these frequencies, if necessary.

- ① Push [(DISP)SET] for 2 sec. to enter set mode.
 - Push [CHG/L] if [(DISP)SET] is not displayed.
- ② Push [▲] or [▼] to select the 'Auto Repeater' item.
 - Left-hand tuning dial can also select the item.

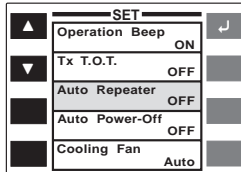

- ③ Rotate the right-hand tuning dial to select the auto repeater function.

U.S.A. version:

- “Dup” Activates duplex only.
- “Dup&Tone” Activates duplex and tone.
- “OFF” Auto repeater function is turned OFF.

Korea version:

- “ON” Activates duplex and tone.
- “OFF” Auto repeater function is turned OFF.

- ④ Push [↵] to exit set mode.



- ① Push [B SET] to enter set mode.
- ② Push [B SET] or [C ENT] to select the 'Auto Repeater' item.
- ③ Push [▲] or [▼] to select the auto repeater function.
- ④ Push [A CLR] to exit set mode.

◇ Frequency range and offset direction

•U.S.A. version

FREQUENCY RANGE	DUPLEX DIRECTION
145.200–145.495 MHz 146.610–146.995 MHz	“DUP–” appears
147.000–147.395 MHz	“DUP” appears
442.000–444.995 MHz	“DUP” appears
447.000–449.995 MHz	“DUP–” appears

•Korea version

FREQUENCY RANGE	DUPLEX DIRECTION
439.000–440.000 MHz	“DUP–” appears

■ General

The transceiver has 99 memory channels and 1 call channel for each band for storage of often-used frequencies.

◇ Memory/call channel contents

The following information can be programmed into memory or call channels:

- Operating frequency (p. 20)
- Operating mode (p. 74)
- 8-character memory name (p. 37)
- Tuning step (p. 21)
- Duplex direction (DUP or DUP-) with an offset frequency (pgs. 26, 30)
- Subaudible tone encoder or tone squelch ON/OFF (pgs. 26, 50)
- Subaudible tone and tone squelch frequencies (pgs. 29, 51)
- Scan skip setting (p. 46)

■ Programming during selection

- ① Select VFO mode with the desired band's [V/MHz].
 - Push [CHG/L] if [V/MHz] is not displayed.
- ② Set the desired frequency:
 - Set the frequency using the desired band's tuning dial.
 - Set other data (e.g. offset frequency, duplex direction, subaudible tone frequency, etc.), if required.
- ③ Push the desired band's [S.MW] momentarily to indicate memory channels.
 - Push [CHG/L] if [S.MW] is not displayed.
 - Do not hold [S.MW] for more than 0.5 sec., otherwise the memory channel will overwrite the selected memory channel.
- ④ Rotate the tuning dial to select the desired channel.
 - Call channel (C), VFO (-) and scan edges (1A – 3B), as well as regular memory channels, can be programmed in this way.
- ⑤ Push [(s.mw)MW] for 2 sec. to program.
 - Memory channel number automatically advances when continuing to push [(S.MW)MW] after programming.

[EXAMPLE]: Programming ch 40 during selection.

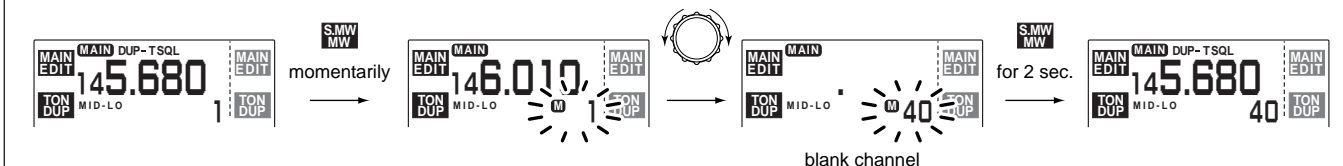

■ Programming after selection

- ① Select memory mode with the desired band's [M/C].
 - Push [CHG/L] if [M/C] is not displayed.
 - “**M**” appears when memory mode is selected.
- ② Set the memory channel to be programmed with the desired band's tuning dial.
- ③ Push [V/MH] to select VFO mode.
- ④ Set the desired frequency:
 - ➔ Set the frequency using the desired band's tuning dial.
 - ➔ Set other data (e.g. offset frequency, duplex direction, subaudible tone frequency, etc.), if required.
- ⑤ Push [(s.MW)MW] for 2 sec. to program into the selected channel.
 - Push [CHG/L] if [(S.MW) MW] is not displayed.
 - Memory channel number automatically advances when continuing to push [MW] after programming.

■ Transferring memory contents to another memory

- ① Select memory mode with the desired band's [M/C].
 - Push [CHG/L] if [M/C] is not displayed.
 - “**M**” appears when memory mode is selected.
- ② Set the desired memory channel with the desired band's tuning dial.
- ③ Push the desired band's [S.MW] momentarily to indicate memory channels.
 - Push [CHG/L] if [S.MW] is not displayed.
 - Push [S.MW] for 2 sec. to transfer the memory channel contents to VFO.
- ④ Rotate the tuning dial to select the desired channel.
 - Call channel (C), VFO (- -) and scan edges (1A – 3B), as well as regular memory channels, can be transferred in this way.
- ⑤ Push [(s.MW)MW] for 2 sec. to transfer.

[EXAMPLE]: Transferring VHF memory channel 3 to 20.



■ Programming during selection via the microphone



The HM-98 microphone can also be used to program memory channels.

- ① Select the desired band with [BAND].
- ② Select VFO mode with [VFO].
- ③ Set the desired frequency.
 - Set other data (e.g. offset frequency, duplex direction, subaudible tone frequency, etc.), if required.
- ④ Push [FUNC] then [ⒶMW] momentarily to indicate memory channels.
 - Do not hold [MW] for more than 0.5 sec., otherwise the memory channel will overwrite the selected memory channel.
- ⑤ Push [▲] or [▼] to select the desired channel.
 - Call channel (C), VFO (- -) and scan edges (1A – 3B), as well as regular memory channels, can be programmed in this way.
- ⑥ Push [FUNC] then [ⒶMW] for 2 sec. to program.
 - Memory channel number automatically advances when continuing to push [MW] after programming.

■ Programming after selection via the microphone



The HM-98 microphone can also be used to program memory channels.

- ① Select the desired band with [BAND].
- ② Select memory mode with [MR].
- ③ Set the desired memory channel to be programmed with [▲] or [▼].
- ④ Push [VFO] to select VFO mode.
- ⑤ Set the desired frequency:
 - Set other data (e.g. offset frequency, duplex direction, subaudible tone frequency, etc.), if required.
- ⑥ Push [FUNC] then [ⒶMW] for 2 sec. to program.
 - Memory channel number automatically advances when continuing to push [MW] after programming.

■ Transferring memory contents to another memory via the microphone



The HM-98 microphone can also be used to transfer memory channels.

- ① Select the desired band with [BAND].
- ② Select memory mode with [MR].
- ③ Set the desired memory channel to be transferred with [▲] or [▼].
- ④ Push [FUNC] then [Ⓜ MW] momentarily to indicate memory channels.
 - Push [MW] for 2 sec. to transfer the memory channel contents to VFO.
- ⑤ Push [▲] or [▼] to select the desired channel.
 - Call channel (C), VFO (- -) and scan edges (1A – 3B), as well as regular memory channels, can be transferred in this way.
- ⑥ Push [FUNC] then [Ⓜ MW] for 2 sec. to transfer.

7 MEMORY/CALL CHANNELS

■ Memory clear

Unwanted memory channels can be cleared (erased). Before clearing a memory channel make sure it is no longer needed as cleared memories cannot be recalled.

- 1 Push the desired band's [S.MW] momentarily.
 - Push [CHG/L] if [S.MW] is not displayed.
 - Do not hold [S.MW] for more than 0.5 sec., otherwise the memory channel will overwrite the selected memory channel or the memory channel contents will be transferred to VFO.
- 2 Set the memory channel to be cleared with the desired band's tuning dial.
- 3 Push [S.MW] briefly, then a second time for 2 sec.
 - 3 beeps sound, then the frequency is cleared.
 - Scan edges 1A/1B and the call channel cannot be cleared.
- 4 Push [MAIN] to return to previous mode.

 Be careful—the contents of cleared memories CANNOT be recalled.



Memory clearing may not be performed from the microphone.

[EXAMPLE]: Clearing memory channel 3.



■ Alphanumeric display

Each memory channel and the call channel can be programmed with an alphanumeric name such as a repeater name, club name, etc., for easy recognition. Names can be a maximum of 8 characters—see the table at right for available characters.

/// Scan edge channels and scratch pad memories CANNOT be programmed with alphanumeric names.

- ① Select the desired memory/call channel except scan edge channels.
- ② Push the desired band's [(MAIN)EDIT] for 2 sec. to enter the edit screen.
 - Push [CHG/L] if [(MAIN)EDIT] is not displayed.
- ③ Push [▲] or [▼] to select the 'Name' item.
 - Left-hand tuning dial can also select the item.

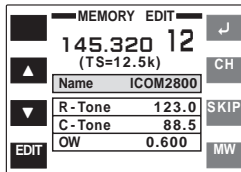

- ④ Push [EDIT] to enter programming mode.
 - The first character of the name flashes.

- ⑤ Rotate the right-hand tuning dial to select the desired character.
 - See the table below for a list of available characters.

<	>	+	-	=	*	/	_	()
:	0	1	2	3	4	5	6	7	8
9	A	B	C	D	E	F	G	H	I
J	K	L	M	N	O	P	Q	R	S
T	U	V	W	X	Y	Z	space		

- ⑥ Push [▶] to advance to the next character.
 - Push [◀] to select the previous character.
- ⑦ Repeat ⑤ and ⑥ until the desired name is input.
- ⑧ Push [↵] to program the name and exit programming mode.
- ⑨ If you want to set other channels, push [CH] then rotate the right-hand tuning dial. Repeat ④ through ⑧ to set the desired name.
- ⑩ Push [↵] again to exit the edit screen.



/// To display the programmed memory name, turn the memory name indication ON in set mode. (p. 67)

7 MEMORY/CALL CHANNELS

■ Call channel

1 call channel is available for each band to store a most-often-used frequency for quick recall.

◇ Selecting a call channel

① Push [M/C] to select a call channel.

- Push [CHG/L] if [M/C] is not displayed.
- “C” appears when call channel is selected.

② Push [V/MH] to select VFO mode, if desired.



- ① Select the desired band with [BAND].
- ② Push [(MR)CALL] for 2 sec. to select the selected band's call channel.

◇ Programming a call channel

- ① Select VFO mode with the desired band's [V/MH].
 - Push [CHG/L] if [V/MH] is not displayed.
- ② Set the desired frequency:
 - ➔ Set the frequency using the desired band's tuning dial.
 - ➔ Set other data (e.g. offset frequency, duplex direction, subaudible tone frequency, etc.), if required.
- ③ Push the desired band's [S.MW] momentarily to indicate memory channels.
 - Push [CHG/L] if [S.MW] is not displayed.
 - Do not hold [S.MW] for more than 0.5 sec., otherwise the memory channel will overwrite the selected memory channel.
- ④ Rotate the tuning dial to select the call channel.
 - “C” appears when a call channel is selected.
- ⑤ Push [(s.MW)MW] for 2 sec. to program.

[EXAMPLE]: Programming a call channel.

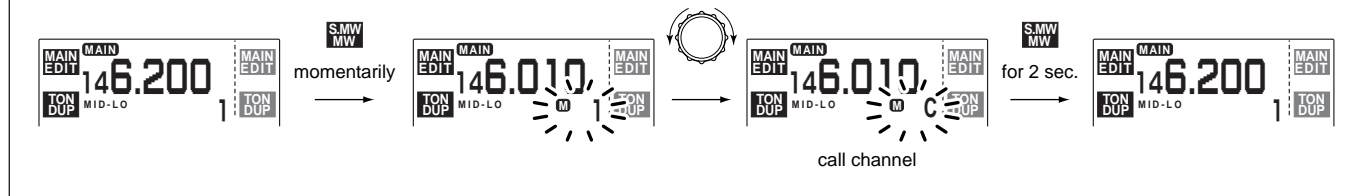

◇ Programming a call channel via the microphone



The HM-98 microphone can also be used to program a call channel.

- ① Select the desired band with [BAND].
- ② Select VFO mode with [VFO].
- ③ Set the desired frequency.
 - Set other data (e.g. offset frequency, duplex direction, subaudible tone frequency, etc.), if required.
- ④ Push [FUNC] then [ⒶMW] momentarily to indicate memory channels.
 - Do not hold [MW] for more than 0.5 sec., otherwise the memory channel will overwrite the selected memory channel.
- ⑤ Push [▲] or [▼] to select the call channel.
 - “C” appears when the call channel is selected.
- ⑥ Push [FUNC] then [ⒶMW] for 2 sec. to program.

◇ Transferring call channel contents

The call channels can be transferred in a similar manner to memory channel transferring.

- ① Select call channel with the desired band's [M/C].
 - Push [CHG/L] if [M/C] is not displayed.
 - “C” appears when the call channel is selected.
- ② Push [(S.MW)MW] for 2 sec. to transfer.
 - Push [CHG/L] if [S.MW] is not displayed.

◇ Transferring call channel contents via the microphone

- ① Select the desired band with [BAND].
- ② Push [(MR)CALL] for 2 sec. to select the desired band's call channel.
 - “C” appears when the call channel is selected.
- ③ Push [FUNC] then [ⒶMW] for 2 sec. to transfer.

■ What is a scratch pad memory?

During VFO operation, the transceiver automatically memorizes operating frequency information, separate from regular memory channels, when transmitting on a new frequency. There are 2 types of scratch pad memories, those for simplex operation, L1–L5, and those for duplex (repeater) operation, R1–R5. These memories can be conveniently recalled.

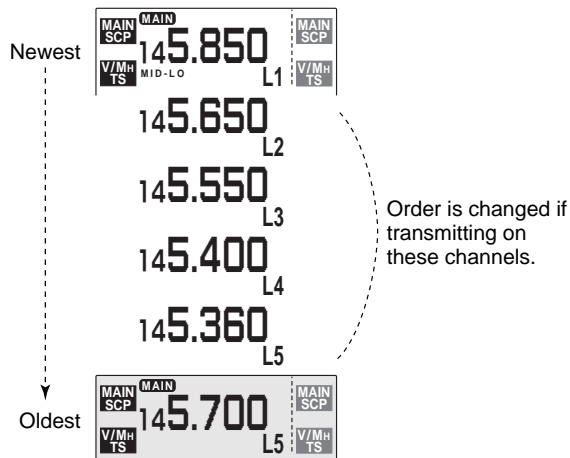

The oldest written frequency is cleared.

When memory mode is selected, the frequency is not programmed into a scratch pad.

■ Calling up a scratch pad memory

- ① Push [M/C] to select the call channel.
 - Push [CHG/L] if [M/C] is not displayed.
 - “C” appears when the call channel is selected.
- ② Rotate the desired band’s tuning dial to select a scratch pad memory.
 - Previously transmitted frequency and one of “L1–L5” appears for simplex memories (rotate tuning dial left); one of “R1–R5” appears for duplex memories (rotate tuning dial right).
 - When first applying power or after CPU resetting, scratch pad memories contain no data and therefore cannot be selected.
- ③ Push [V/MH] or [M/C] to exit the scratch pad memory.

- The 5th scratch pad memory (L5 or R5) will be cleared when transmitting on a new frequency. If the transmit frequency is already stored in a scratch pad memory, the scratch pad memory is not cleared but the order is changed.
- When transmitting on a scratch pad memory, that memory becomes the 1st scratch pad memory (L1 or R1) and the order is changed.



- ① Select the desired band with [BAND].
- ② Push [(MR)CALL] for 2 sec. to select the selected band's call channel.
- ③ Push [▲] one or more times to select a duplex scratch pad memory; push [▼] one or more times to select a simplex scratch pad memory.
- ④ Push [MR] or [VFO] to exit the scratch pad memory.

■ Transferring scratch pad memory contents

Transferring scratch pad memory contents to the VFO is done similarly to transferring memory/call contents.

- ① Push [M/C] to select the call channel.
 - Push [CHG/L] if [M/C] is not displayed.
 - “C” appears when the call channel is selected.
- ② Rotate the desired band's tuning dial to select the desired scratch pad memory.
 - One of “L1” to “L5” or “R1” to “R5” appears.
- ③ Push the desired band's [S.MW] momentarily to indicate memory channels.
 - Push [S.MW] for 2 sec. to transfer the scratch pad memory to VFO.

- ④ Rotate the desired band's tuning dial to select the desired memory channel.
- ⑤ Push [(S.MW)MW] for 2 sec. to transfer.



- ① Select the desired band with [BAND].
- ② Push [(MR)CALL] for 2 sec. to select the selected band's call channel.
- ③ Push [▲] one or more times to select a duplex scratch pad memory; push [▼] one or more times to select a simplex scratch pad memory to be transferred.
- ④ Push [FUNC] then [ⒶMW] momentarily to indicate memory channels.
 - Push [MW] for 2 sec. to transfer the scratch pad memory to VFO.
- ⑤ Push [▲] or [▼] to select the desired channel.
 - Call channel (C), VFO (- -) and scan edges (1A – 3B), as well as regular memory channels, can be transferred in this way.
- ⑥ Push [FUNC] then [ⒶMW] for 2 sec. to transfer.

Scan types

Scanning searches for signals automatically and makes it easier to locate new stations for contact or listening purposes. There are 3 scan types and 4 resume conditions to suit your operating needs.

FULL/BAND SCAN (p. 43)

Repeatedly scans all frequencies over the entire band. Used as the simplest scan without any preliminary settings necessary.

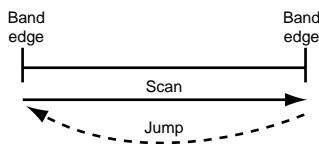

PROGRAMMED SCAN (p. 43)

Repeatedly scans between two user-programmed frequencies. Used for checking for frequencies within a specified range such as repeater output frequencies, etc. 3 pairs of scan edges are available.

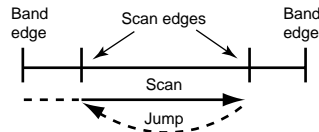

MEMORY SCAN (p. 45)

Repeatedly scans memory channels except those set as skip channels. Used to search through often-used memories and for bypassing normally busy channels such as repeater frequencies.

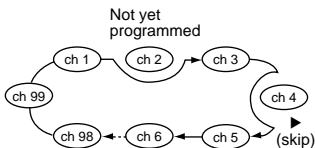

SCAN RESUME CONDITION (p. 46)

4 resume conditions are available: 3 timer scans and pause scan. When receiving a signal, pause scan pauses until the signal disappears; timer scans pause for 5, 10 or 15 sec.

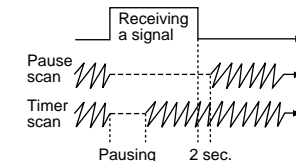

■ Full/programmed scan

- ① Select VFO mode with the desired band's [V/MHz].
 - Push [CHG/L] if [V/MHz] is not displayed.
- ② Make sure the squelch is set to the threshold point.
- ③ Push [(M/C)SCN] for 2 sec. to enter scan screen.
 - If the pocket beep function is activated, the transceiver automatically selects the tone squelch function when the scan screen is selected.

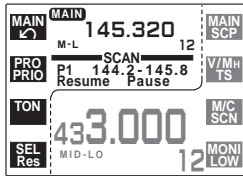

- ④ Push [SEL] one or more times to select the desired scan edges, if necessary. See p. 44 for details.
 - “AL” for full scan, “AA” for air band scan (U.S.A. and S. America versions only), “A1”/“A4” for 144 MHz/430(440) MHz band scan or “P1”–“P3” for programmed scan.
 - Only programmed scan edges can be selected.
- ⑤ Push [PRO] momentarily to start the scan.
 - Decimal point flashes while scanning.
 - “AL,” “AA”/“A1”/“A4” or “P1”–“P3” flashes to indicate full scan, band scan or programmed scan edges, respectively.
 - To change the scanning direction, rotate the desired band's tuning dial.
 - To change the scan edges, push [SEL] one or more times.

- ⑥ To stop the scan, push [PRO] again.
- ⑦ Push [(MAIN)↶] for 2 sec. to exit the scan screen.

▨ If the same frequencies are programmed into a pair of scan edges, programmed scan does not start.

▨ For programmed scan, scan edges must be programmed in advance. Program scan edges into scan edge memory channels (1A–3B). (p. 32)



- ① Select the desired band with [BAND].
- ② Select VFO mode with [VFO].
- ③ Push [SQL▲] or [SQL▼] to set the squelch to the threshold point.
- ④ Select the desired scan edges using the controller unit, if necessary. See p. 44 for details.
 - “AL” for full scan, “AA” for air band scan (U.S.A. and S. America versions only), “A1”/“A4” for 144 MHz/430(440) MHz band scan or “P1”–“P3” for programmed scan.
 - Only programmed scan edges can be selected.
- ⑤ Push [②SCAN] momentarily to start a scan. Push [▲]/[▼] for 2 sec. to start a band scan.
 - “AL,” “AA”/“A1”/“A4” or “P1”–“P3” flashes to indicate full scan, band scan or programmed scan edges, respectively.
- ⑥ Push [▲], [▼] or [ⒶCLR] to cancel the scan.

9 SCAN OPERATION

■ Selecting scan edges

The scanning range can be set to all frequencies (full scan) or between two user-programmed frequencies (programmed scan).

Scan edges can be programmed in the same manner as memory channels. Scan edges are programmed into scan edges, 1A/1B to 3A/3B, in memory channels. (p. 32)

- 1 Push [(M/C)SCN] for 2 sec. to enter the scan screen.
 - Push [CHG/L] if [(M/C)SCN] is not displayed.
 - If the pocket beep function is activated, the transceiver automatically selects the tone squelch function when the scan screen is selected.

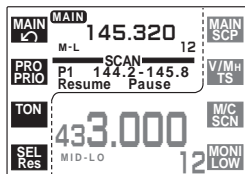

- 2 Push [SEL] one or more times to select the desired scan edges, if necessary.
 - "AL" for full scan, "AA" for air band scan (U.S.A. and S. America versions only), "A1"/"A4" for 144 MHz/430(440) MHz band scan or "P1"—"P3" for programmed scan.
 - Only programmed scan edges can be selected.

- 3 Push [(MAIN)↶] for 2 sec. to exit the scan screen.



Scan edge selection may not be performed from the microphone.

Memory scan

- ① Select memory mode with the desired band's [M/C].
 - Push [CHG/L] if [M/C] is not displayed.
 - "M" appears when memory mode is selected.
- ② Make sure the squelch is set to the threshold point.
- ③ Push [(M/C)SCN] for 2 sec. to enter the scan screen.
 - If the pocket beep function is activated, the transceiver automatically selects the tone squelch function when the scan screen is selected.

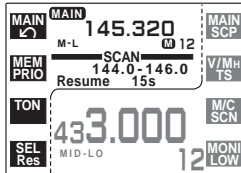

- ④ Push [MEM] momentarily to start the scan.
 - Decimal point and "M" flash while scanning.
 - To change the scanning direction, rotate the desired band's tuning dial.
- ⑤ To stop the scan, push [MEM] again.
- ⑥ Push [(MAIN)↶] for 2 sec. to exit the scan screen.



- ① Select the desired band with [BAND].
- ② Select memory mode with [MR].
- ③ Push [SQL▲] or [SQL▼] to set the squelch to the threshold point.
- ④ Push [②SCAN] momentarily or [▲]/[▼] for 2 sec. to start memory scan.
 - Decimal point and "M" flash while scanning.
- ⑤ Push [▲], [▼] or [ⒶCLR] to cancel the scan.

At least 2 memory channels must be programmed for memory scan to start.

9 SCAN OPERATION

■ Skip channel setting

Memory channels can be set to be skipped for memory skip scan. In addition, memory channels can be set to be skipped for both memory skip scan and full/band/programmed scan (frequency skip scan). This is useful to speedup the scan interval.

- ① Select a memory channel you wish to set skip information.
- ② Push the desired band's [(MAIN)EDIT] for 2 sec. to enter the edit screen.
 - Push [CHG/L] if [(MAIN)EDIT] is not displayed.

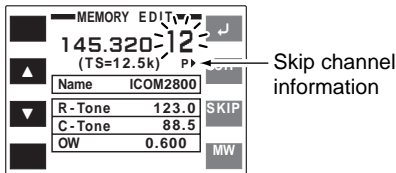

- ③ Push [SKIP] to select the condition.
 - “▶” for memory skip scan.
 - “P▶” for frequency skip scan and memory skip scan.
 - No “▶” or “P▶” indication for no skipping of channels.
- ④ If you want to set other channels, rotate the right-hand tuning dial. Repeat ③ to set the desired condition.
 - Push [CH] if memory channel does not flash.
- ⑤ Push [↵] to exit the edit screen.

■ Scan resume condition

The scan resume condition can be selected as a pause or timer scan for each band. When receiving signals, the scan pauses according to the scan resume condition.

- ① Push the desired band's [(M/C)SCN] for 2 sec. to enter scan screen.
 - Push [CHG/L] if [(M/C)SCN] is not displayed.
- ② Push [(SEL)Res] one or more times for 2 sec. to select condition.
 - “5s” : scan pauses for 5 sec. on a received signal.
 - “10s” : scan pauses for 10 sec. on a received signal.
 - “15s” : scan pauses for 15 sec. on a received signal.
 - “Pause” : scan pauses on a received signal until it disappears.

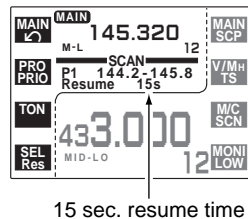

- ③ Push [(MAIN)↵] for 2 sec. to exit scan screen.

■ Operation

The band scope function allows you to visually check a specified frequency range. Sweep range varies ± 50 kHz through ± 500 kHz with setting of the sweep tuning steps.

Receive audio is muted while monitoring the band scope.
 Push [SWP] to cancel sweeping and receive the audio.

- ① Set the desired frequency as band scope center frequency.
- ② Push the desired band's [(MAIN)SCP] for 2 sec. to select the band scope screen.
 - Push [CHG/L] if [(MAIN) SCP] is not displayed.
- ③ A sweep automatically starts and signal conditions (strengths) appear starting from the center of the range.

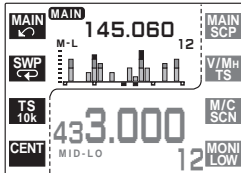

- ④ Push [SWP] momentarily to begin another sweep.
 - "→|" appears while sweeping.
- ⑤ Push [(SWP) ↔] for 2 sec. to begin sweeping continuously.
 - Push [SWP] again to cancel sweeping.

- ⑥ Push [TS] to select the sweep tuning step, if desired.
 - 5, 10, 15, 20, 25, 30 and 50 kHz sweep tuning steps are available when a tuning step other than 12.5 kHz is selected.
 - 12.5, 25 and 50 kHz sweep tuning steps are available when 12.5 kHz tuning step is selected.
- ⑦ Rotate the desired band's tuning dial to set the highlighted cursor to the desired waveform and set the frequency of the signal.
 - Push [CENT] to return the operating frequency to the center frequency.
- ⑧ Push [(MAIN) ↶] for 2 sec. to exit the band scope screen.

11 PRIORITY WATCH

■ Priority watch types

Priority watch checks for signals on a frequency every 5 sec. while operating on a VFO frequency. The transceiver has 2 priority watch types to suit your needs.

The watch resumes according to the selected scan resume condition. See p. 46 for details.

MEMORY or CALL CHANNEL WATCH

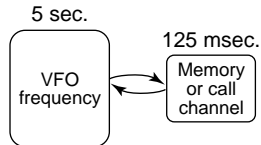

While operating on a VFO frequency, priority watch checks for a signal on the selected memory or call channel every 5 sec.

- A memory channel with skip information can be watched.

MEMORY SCAN WATCH

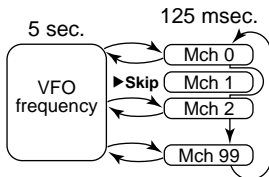

While operating on a VFO frequency, priority watch checks for signals on each memory channel in sequence.

- The memory skip function is useful to speed up the scan.

■ Priority watch operation

- ① Select VFO mode with the desired band's [V/MH].
 - Push [CHG/L] if [V/MH] is not displayed.
- ② Set an operating frequency.
- ③ Make sure the squelch is set to the threshold point.
- ④ Set the watching channel(s).

For memory channel watch:

Select the desired memory channel.

- Select memory mode with the desired band's [M/C] (“**M**” appears.); select the memory channel to be watched with the desired band's tuning dial.

For memory scan watch:

Start the memory scan.

- Select memory mode with the desired band's [M/C] (“**M**” appears.); push [(M/C) SCN] for 2 sec. to select scan screen; push [MEM] to start memory scan.

For call channel watch:

Select the call channel by pushing [M/C].

- Select memory mode with the desired band's [M/C]. (“**C**” appears.)

- ⑤ Push [(M/C) SCN] for 2 sec. to select the scan screen.
 - If the pocket beep function is activated, the transceiver automatically selects the tone squelch function when scan screen is selected.

- ⑥ Push [(MEM)PRIO] for 2 sec. to start the watch.
- The transceiver checks the memory or call channel frequency every 5 sec.
 - The watch resumes according to the selected scan resume condition. (p. 46)
 - “PRIO” and decimal point blinks while receiving a signal on a watch channel.

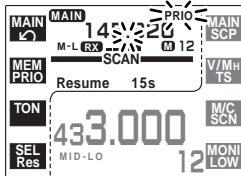

- ⑦ Push [(MEM)PRIO] while the display shows the VFO frequency to stop the watch.

PRIO
3

- ① Select the desired band with [BAND].
- ② Select VFO mode with [VFO].
- ③ Set an operating frequency.
- ④ Push [SQL▲] or [SQL▼] to set the squelch to the threshold point.
- ⑤ Set the watching channel(s).

For memory channel watch:

Select the desired memory channel.

- Select memory mode with [MR]; select the memory channel to be watched with [▲]/[▼].

For memory scan watch:

Start the memory scan.

- Select memory mode with [MR]; push [(2)SCAN] momentarily or [▲]/[▼] for 2 sec. to start memory scan.

For call channel watch:

Select the call channel by pushing [(MR)CALL] for 2 sec.

- ⑥ Push [(3)PRIO] to start the watch.
 - The transceiver checks the memory or call channel frequency every 5 sec.
 - The watch resumes according to the selected scan resume condition. (p. 46)
 - “PRIO” and decimal point blinks while receiving a signal on a watch channel.
- ⑦ Push [(3)PRIO] or [(A)CLR] while the display shows the VFO frequency to stop the watch.

12 SUBAUDIBLE TONE OPERATION

■ Tone squelch operation

The tone squelch opens only when receiving a signal containing a matching subaudible tone. You can silently wait for calls from group members using the same tone.

- ① Select the desired band with the desired band's [MAIN].
- ② Set an operating frequency.
- ③ Set the desired CTCSS tone using the edit screen.
 - See right for programming.
- ④ Push [TON] one or more times until "TSQL" appears in the function display.
 - Push [CHG/L] if [TON] is not displayed.
- ⑤ When the received signal includes a matching tone, squelch opens and the signal can be heard.
 - When the received signal's tone does not match, tone squelch does not open, however, the S-indicator shows signal strength.
 - To open the squelch manually, push [MONI].
- ⑥ Operate the transceiver in the normal way.
- ⑦ To cancel the tone squelch, push [TON] one or more times to clear "TSQL."

○ CONVENIENT

Store subaudible tone frequencies and tone squelch ON/OFF settings in memories (call) for easy recall.



- ① Select the desired band with [BAND].
- ② Set an operating frequency.
- ③ Set the desired CTCSS tone in the edit screen using the remote controller unit.
 - See right for programming.
- ④ Push [FUNC] then [⑨ TSQL] to activate the tone squelch.
- ⑤ When the received signal includes a matching tone, squelch opens and the signal can be heard.
 - When the received signal's tone does not match, tone squelch does not open, however, the S-indicator shows signal strength.
 - To open the squelch manually, push [① MONI].
- ⑥ Operate the transceiver in the normal way.
- ⑦ To cancel the tone squelch, push [FUNC] then [© T-OFF].

◇ Setting subaudible tones for tone squelch operation (CTCSS tones)

Separate tone frequencies can be set for tone squelch operation than for repeater operation (the same range of tones is available). Like repeater tones, these are set in the edit screen.

- ① Select the mode/channel you wish to set the CTCSS tone frequency to, such as VFO mode or memory/call channel.
- ② Push the desired band's [(MAIN)EDIT] for 2 sec. to enter the edit screen.
 - Push [CHG/L] if [(MAIN)EDIT] is not displayed.
- ③ Push [▲] or [▼] to select the 'C-Tone' item.
 - Left-hand tuning dial can also select the item.

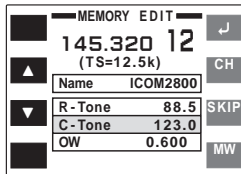

- ④ Rotate the right-hand tuning dial to select the desired frequency.
 - The CTCSS tone frequency is set temporarily. Push [MW] for 2 sec. to store the tone frequency permanently.
 - The color of the frequency indication changes when the setting is different from the memory or call channel contents.

- ⑤ If you want to set other channels, push [CH] then rotate the right-hand tuning dial. Repeat ③ and ④ to select the desired frequency.
- ⑥ Push [↵] to exit the edit screen.

▨ The tone frequency can be set in a memory channel temporarily. However, the set contents are cleared once the other memory/call channel is selected. To store the tone frequency permanently, push [MW] for 2 sec. at step ④ to overwrite the information.

• Available CTCSS tone frequencies (unit: Hz)

67.0	82.5	100.0	123.0	151.4	171.3	189.9	210.7	250.3
69.3	85.4	103.5	127.3	156.7	173.8	192.8	218.1	254.1
71.9	88.5	107.2	131.8	159.8	177.3	196.6	225.7	
74.4	91.5	110.9	136.5	162.2	179.9	199.5	229.1	
77.0	94.8	114.8	141.3	165.5	183.5	203.5	233.6	
79.7	97.4	118.8	146.2	167.9	186.2	206.5	241.8	

▨ The transceiver has 50 tone frequencies and consequently their spacing is narrow. Therefore, some tone frequencies may receive interference from adjacent tone frequencies.

12 SUBAUDIBLE TONE OPERATION

■ Pocket beep operation

This function uses subaudible tones for calling and can be used as a “common pager” to inform you that someone has called while you were away from the transceiver.

◇ Waiting for a call from a specific station

- ① Select the desired band with the desired band's [MAIN].
- ② Set an operating frequency.
- ③ Set the desired CTCSS tone using the edit screen.
 - See the previous page for programming.
- ④ Push [TON] one or more times until “T SQL·)” appears in the function display.
 - Push [CHG/L] if [TON] is not displayed.
- ⑤ When a signal with the correct tone is received, the transceiver emits beep tones for 30 sec. and flashes “·)”.”
- ⑥ Push [PTT] to answer or push [TON] to stop the beeps and flashing.
 - Tone squelch is automatically selected.
- ⑦ To cancel the pocket beep, push [TON] one or more times to clear “T SQL.”

◇ Calling a waiting station using pocket beep

A subaudible tone matched with the station's tone frequency is necessary. Use the tone squelch on p. 50 or a subaudible tone encoder.



- ① Select the desired band with [BAND].
- ② Set an operating frequency.
- ③ Set the desired CTCSS tone in the edit screen using the remote controller unit.
 - See the previous page for programming.
- ④ Push [FUNC] then [8 TSQL (·)] to activate the pocket beep.
- ⑤ When the received signal includes a matching tone, the transceiver emits beep tones for 30 sec. and flashes “·)”.”
- ⑥ Push [PTT] to answer or push [A CLR] to stop the beeps and flashing.
 - Tone squelch is automatically selected.
- ⑦ To cancel the pocket beep, push [FUNC] then [C T-OFF].

■ Tone scan

The transceiver can detect the subaudible tone frequency in a received signal. By monitoring a signal that is being transmitted on a repeater input frequency, you can determine the tone frequency required to access the repeater.

- ① Set the desired frequency or memory channel to be checked for a tone frequency.
- ② Turn the tone squelch ON or OFF to check the tone squelch frequency or repeater tone frequency, respectively. (p. 50)
- ③ Push the desired band's [(M/C)SCN] for 2 sec. to enter the scan screen.
 - Push [CHG/L] if [(M/C)SCN] is not displayed.
 - If the pocket beep function is activated, the transceiver automatically selects the tone squelch function when the scan screen is selected.
- ④ Push [TON] momentarily to start the tone scan.
 - Decimal point flashes while scanning.
 - To change the scanning direction, rotate the desired band's tuning dial.

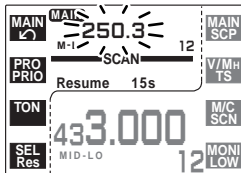

- ⑤ When the tone frequency is detected, the tone scan pauses.
 - The tone frequency is set temporarily on a memory or call channel. Program into the memory or call channel to store the tone frequency permanently.
 - The decoded tone frequency is used for the repeater tone frequency or tone squelch frequency, depending on the tone squelch ON/OFF setting.
- ⑥ To stop the scan, push [TON] again.
- ⑦ Push [(MAIN)↶] for 2 sec. to exit the scan screen.

13 DTMF MEMORY

■ Programming a DTMF code

DTMF codes are used for autopatching, accessing repeaters, controlling other equipment, etc. The transceiver has 14 DTMF memory channels (D0–D9, DA–DD) for storage of often-used DTMF codes of up to 16 digits.

- 1 Push [DTMF] for 2 sec. to select the DTMF memory screen.
 - Push [CHG/L] if [DTMF] is not displayed.

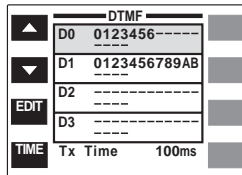

- 2 Push [▲] or [▼] to select the desired DTMF memory.
 - Left-hand tuning dial can also select the item.
- 3 Push [EDIT] to enter programming mode.
 - The first character of the DTMF code flashes.

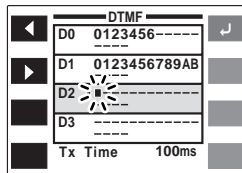



- 4 Rotate the right-hand tuning dial to select the desired character.
 - "E" stands for "*" and "F" stands for "#."
 - "-" indicates 'no code' and can be used to clear a previously programmed code.
- 5 Push [▶] to advance to the next character.
 - Push [◀] to select the previous character.
- 6 Repeat 4 and 5 until the desired code is input.
- 7 Push [↵] to program the DTMF code and exit programming mode.
- 8 If you want to set other channels, repeat 2 through 7.
- 9 Push [↵] to exit the DTMF memory screen.



■ Transmitting a DTMF code

◇ Automatic transmission (DTMF memory)

The selected DTMF code is transmitted at each push of the PTT switch when the DTMF memory encoder is turned ON.

- ① Push [DTMF] to turn the DTMF memory encoder ON.
 - Push [CHG/L] if [DTMF] is not displayed.
 - “ - Left-hand tuning dial can also select the item.
- ④ Push [- Each push of [PTT] transmits the DTMF code.
- The speaker emits the DTMF tones sent.
- ⑥ Push [DTMF] to cancel the DTMF memory encoder.
 - “



 A small icon showing the text "DTMF" above the number "6", enclosed in a rounded rectangular border.

- ① Push [FUNC] then [] to turn the DTMF memory encoder ON.
 - “ - Follow steps ② through ④ above.
 - See the previous page for programming.

- ③ Push [PTT] to transmit the selected DTMF code.
 - Each push of [PTT] transmits the DTMF code.
- ④ Push [ CLR] to cancel the function.

◇ Transmitting a DTMF memory directly



- ① Push [FUNC] then [] to turn the DTMF memory encoder ON.
 - “ - Function indicator on the HM-98 lights green.
- ③ Push the desired DTMF channel number.
 - “0” to “9” and “A” to “D” are available for channel numbers.
- ④ Push [DTMF-S] again to deactivate the DTMF setting.
 - Function indicator on the HM-98 disappears.
- ⑤ Push [ CLR] to turn the DTMF memory encoder OFF.
 - When the DTMF memory encoder is turned ON continuously, each push of the PTT transmits the previously selected DTMF code.

13 DTMF MEMORY

■ DTMF speed

The rate at which DTMF memories send individual DTMF characters can be set to accommodate operating needs.

- ① Push [DTMF] for 2 sec. to select the DTMF memory screen.
 - Push [CHG/L] if [DTMF] is not displayed.

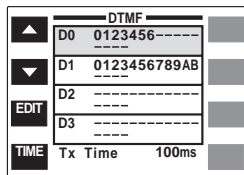

- ② Push [TIME] one or more times to select the desired speed as shown in the table below.
- ③ Push [↵] to exit the DTMF memory screen.

DISPLAY	INTERVAL	SPEED
100ms	100 msec.	5.0 cps
200ms	200 msec.	2.5 cps
300ms	300 msec.	1.6 cps
500ms	500 msec.	1.0 cps

cps=characters/sec.

■ Connection

Wireless remote control is available when the following options are used.

◆ HM-90 WIRELESS MICROPHONE

◆ EX-1759 INFRARED RECEIVER

◇ Recommended connection

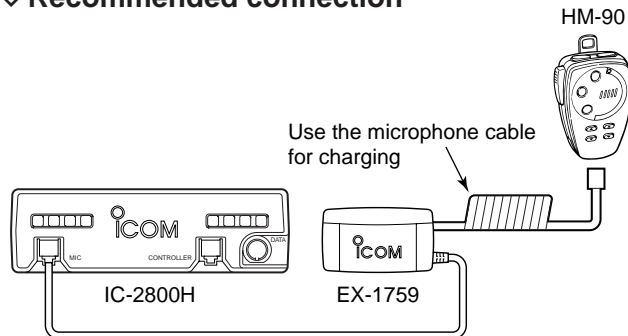

■ HM-90 wireless microphone

The HM-90's internal battery should be charged when the microphone is not being held.

Charging period : 1.5 hr. with timer

(or 8 hr. when battery is exhausted)

Operating period : 12 hr. (operation:standby=1:4)

◇ Charging method

Choose one of the following methods:

- ➔ Connect the supplied microphone cable from the HM-90 to the EX-1759.
- ➔ Connect the supplied microphone cable from the HM-90 to the main unit.

◇ Turning the wireless remote ON/OFF

When you use the HM-90 as a wired microphone, the wireless remote control circuit can be turned OFF.

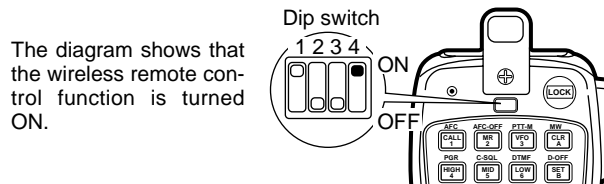

14 WIRELESS OPERATION

■ EX-1759 installation

The EX-1759 INFRARED RECEIVER can be installed for 2 different purposes depending on the HM-90 charger. This is because the EX-1759 has both an infrared receiver and a microphone connector which contains microphone charging capabilities.

When using the IC-2800H main unit

Attach the EX-1759 to a suitable location for receiving infrared signals, e.g. sun visor, etc.

When using the connector for a microphone charger

Attach the EX-1759 to a suitable location for receiving infrared signals and where it can be connected to cable, e.g. the console, etc.

/// **DO NOT** attach the EX-1759 where it will be subject to direct sunlight as it cannot detect infrared signals under such conditions.

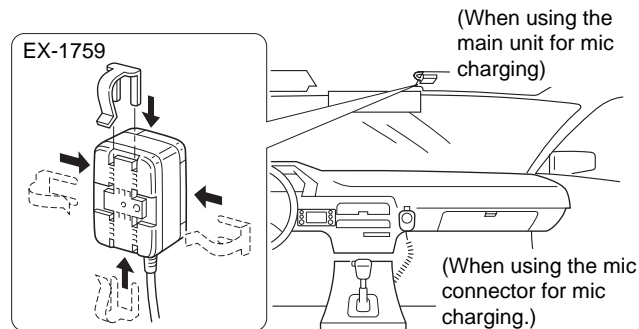

The installation clip can be oriented in 1 of 4 ways.

Optional infrared sub receiver

An optional EX-1513 INFRARED SUB RECEIVER is available to increase the remote control reliability and extend the controllable area. Connect the EX-1513 to the inside connector of the EX-1759.

/// The HM-98 can be connected and used with the EX-1759, however, the optional wireless microphone cannot be used in such a case.

■ HM-90 switches

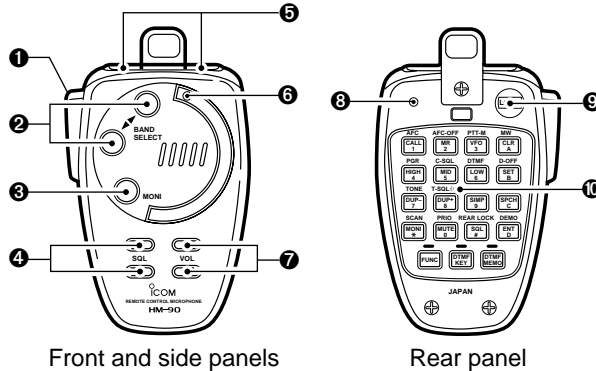

Front and side panels

Rear panel

1 PTT SWITCH

- ➔ Push and hold to transmit; release to receive.
- ➔ Toggles between transmitting and receiving while the one-touch PTT function is in use.

2 BAND SWITCHES [BAND SELECT ▲, ▼]

- ➔ Push to select the operating band.
- ➔ Activate the sub band access function after pushing [FUNC] on the HM-90 rear panel.

3 MONITOR SWITCH [MONI]

Toggles the monitor function ON and OFF.

4 SQUELCH LEVEL UP/DOWN SWITCHES

[▲SQL], [▼SQL]

Adjust the squelch level.

5 FREQUENCY UP/DOWN SWITCHES [UP], [DN]

➔ Push either switch to change the operating frequency, memory channel, set mode contents, etc.

➔ Push and hold either switch to start scanning.

6 ACTIVITY INDICATOR

Lights red while a key is pushed; lights green while the one-touch PTT function is in use.

7 AUDIO VOLUME UP/DOWN SWITCHES

[▲VOL], [▼VOL]

Adjust the audio output level.

8 MODE INDICATOR

Indicates the microphone condition.

- Lights red when [FUNC] is pushed.
- Lights green when [DTMF KEY] is pushed.
- Lights orange when [DTMF MEMO] is pushed.















9 LOCK SWITCH [LOCK]









Locks all switches and keys on the microphone except for the PTT switch.

10 KEYPAD

Used for controlling the transceiver, transmitting a DTMF memory channel, etc.

14 WIRELESS OPERATION

KEY	FUNCTION	SECONDARY FUNCTION (after )	OTHER FUNCTIONS
	Selects the call channel.	No secondary function.	<ul style="list-style-type: none"> • After  : Input the appropriate digit for frequency or memory channel selection. • After  : Transmit the appropriate DTMF code. • After  : Transmit the appropriate DTMF memory contents. [0] to [9], [A] to [D] can be used for DTMF memory.
	Selects memory mode.	No secondary function.	
	Selects VFO mode.	Turns the one-touch PTT function ON and OFF.	
	Selects high output power.	No secondary function.	
	Selects mid-high output power.	No secondary function.	
	Selects low output power.	Turns the DTMF memory function ON.	
	Selects –duplex.	Turns the subaudible tone encoder ON.	
	Selects +duplex.	Turns the pocket beep function ON.	
	Selects simplex.	Turns the tone squelch function ON.	
	Mutes audio signals.	Starts and stops a priority watch.	

KEY	FUNCTION	SECONDARY FUNCTION (after )	OTHER FUNCTIONS
	<p>Clears a digit before entry.</p> <p>Cancels the scan, priority watch, or DTMF memory function.</p>	<p>Writes the VFO contents into the memory channel or call channel.</p> <p>Advances the memory channel number when continuously pushed after programming is completed.</p>	<p>• After  :</p> <p>Transmit the appropriate DTMF code.</p> <p>[* MONI] Transmits a 1750 Hz tone call signal for 0.5 sec.</p> <p>[# SQL] Transmits a 1750 Hz tone call signal while pushing.</p>
	<p>Enters set mode and advances the set mode selection order.</p>	<p>Turns the DTMF memory function OFF.</p>	
	<p>Decreases the set mode selection order after entering set mode.</p> <p>NOTE: The IC-2800H has no voice synthesizer function.</p>	<p>Turns the subaudible tone encoder, pocket beep or tone squelch OFF.</p>	
	<p>Sets the keypad for numeral input.</p>	<p>Enters and exits demonstration mode.</p>	
	<p>Toggles between opening and closing the squelch.</p>	<p>Starts and stops scanning.</p>	
	<p>No function.</p>	<p>Locks all the keys on the microphone's rear panel.</p>	

14 WIRELESS OPERATION

Microphone address

The transceiver has 8 possible microphone addresses (including OFF) to help prevent interference from other HM-90 wireless microphones. Set both the microphone address and microphone dip switch to the same value as follows.

When the supplied microphone is connected, the transceiver rejects control signals from the HM-90 even when the microphone address is matched.

Microphone address

- Push [(DISP)SET] for 2 sec. to enter set mode.
 - Push [CHG/L] if [(DISP)SET] is not displayed.
- Push [▲] or [▼] to select the 'HM-90 Address' item.
 - Left-hand tuning dial can also select the item.
- Rotate the right-hand tuning dial to set the microphone address to 0–7 or to turn the microphone control OFF.
 - When "OFF" is selected, the transceiver rejects all control signals from the HM-90.
- Push [↵] to exit set mode.

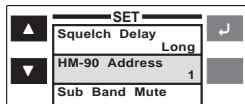

- Push [SET]; then push [SET] or [ENT] to select the 'HM-90 Address' item.
- Push [▲] or [▼] to set the microphone address to 0–7 or to turn the microphone control OFF.
- Push [CLR] to exit set mode.

Microphone dip switch

- Remove the switch cover from the microphone rear panel.
- Set the microphone dip switch and the microphone address to the same value as shown below.
- Replace the switch cover.

MICROPHONE ADDRESS	DIP SWITCH		
	S1-1	S1-2	S1-3
0	OFF	OFF	OFF
1 (default)	ON	OFF	OFF
2	OFF	ON	OFF
3	ON	ON	OFF
4	OFF	OFF	ON
5	ON	OFF	ON
6	OFF	ON	ON
7	ON	ON	ON

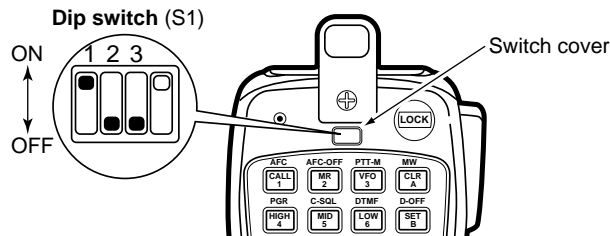

■ Beep tones

You can select silent operation by turning beep tones OFF or you can select to have confirmation beeps sound at the push of a switch by turning beep tones ON.

- ① Push [(DISP)SET] for 2 sec. to enter set mode.
 - Push [CHG/L] if [(DISP)SET] is not displayed.
- ② Push [▲] to select the 'Operation Beep' item.
 - Left-hand tuning dial can also select the item.

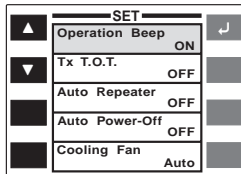

- ③ Rotate the right-hand tuning dial to turn the confirmation beep ON or OFF.
- ④ Push [↵] to exit set mode.



- ① Push [ⓑSET] to enter set mode.
- ② Push [ⓑSET] to select the 'Operation Beep' item.
- ③ Push [▲] or [▼] to turn the confirmation beep ON or OFF.
- ④ Push [ⒶCLR] to exit set mode.

■ Time-out timer

To prevent accidental prolonged transmission with the one-touch PTT function, etc., the transceiver has a time-out timer. This timer cuts a transmission OFF after 3, 5, 15 or 30 min. of continuous transmission. This timer can be cancelled (default).

Approx. 10 sec. before the time-out timer is activated, the transceiver emits a beep tone as a warning.

- ① Push [(DISP)SET] for 2 sec. to enter set mode.
 - Push [CHG/L] if [(DISP)SET] is not displayed.
- ② Push [▲] or [▼] to select the 'Tx T.O.T.' item.
 - Left-hand tuning dial can also select the item.
- ③ Rotate the right-hand tuning dial to select the desired time-out time or turn the timer OFF.
- ④ Push [↵] to exit set mode.

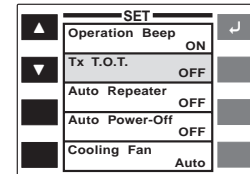

- ① Push [ⓑSET] to enter set mode.
- ② Push [ⓑSET] or [ⓒENT] to select the 'Tx T.O.T.' item.
- ③ Push [▲] or [▼] to select the desired time-out time or turn the timer OFF.
- ④ Push [ⒶCLR] to exit set mode.

15 OTHER FUNCTIONS

■ Auto power-off function

The transceiver can be set to automatically turn OFF after a specified period in which no operations are performed.

2 hours, 1 hour, 30 min. and OFF can be specified. The specified period is retained even when the transceiver is turned OFF by the auto power-off function. To cancel the function, select "OFF" in step ③ below.

- ① Push [(DISP)SET] for 2 sec. to enter set mode.
 - Push [CHG/L] if [(DISP)SET] is not displayed.
- ② Push [▲] or [▼] to select the 'Auto Power-Off' item.
 - Left-hand tuning dial can also select the item.
- ③ Rotate the right-hand tuning dial to select the desired auto power-off time or turn the function OFF.
- ④ Push [↵] to exit set mode.

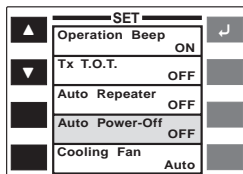

- ① Push [B]SET] to enter set mode.
- ② Push [B]SET] or [C]ENT] to select the 'Auto Power-Off' item.
- ③ Push [▲] or [▼] to select the desired auto power-off time or turn the function OFF.
- ④ Push [A]CLR] to exit set mode.

■ Cooling fan

The transceiver has a heatsink and cooling fan to radiate heat. The cooling fan automatically turns ON while transmitting and remains ON for 2 min. after transmitting. The cooling fan can be activated continuously, if desired.

- ① Push [(DISP)SET] for 2 sec. to enter set mode.
 - Push [CHG/L] if [(DISP)SET] is not displayed.
- ② Push [▲] or [▼] to select the 'Cooling Fan' item.
 - Left-hand tuning dial can also select the item.
- ③ Rotate the right-hand tuning dial to set the cooling fan to automatic ("Auto") or continuous ("ON").
- ④ Push [↵] to exit set mode.

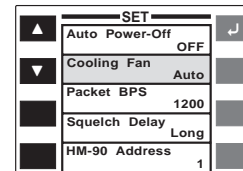

- ① Push [B]SET] to enter set mode.
- ② Push [B]SET] or [C]ENT] to select the 'Cooling Fan' item.
- ③ Push [▲] or [▼] to set the cooling fan to automatic ("Auto") or continuous ("ON").
- ④ Push [A]CLR] to exit set mode.

■ Squelch delay

During operation, received signal strength often fluctuates. This can result in annoying repeated opening and closing of the squelch during reception of the same signal. The transceiver has a built-in squelch delay function which helps prevent this. When both stations are operating from a fixed location e.g. during packet operation, this function should be set to “short.”

- ① Push [(DISP)SET] for 2 sec. to enter set mode.
 - Push [CHG/L] if [(DISP)SET] is not displayed.
- ② Push [▲] or [▼] to select the ‘Squelch Delay’ item.
 - Left-hand tuning dial can also select the item.
- ③ Rotate the right-hand tuning dial to set the squelch delay to “Long” or “Short.”
- ④ Push [↵] to exit set mode.

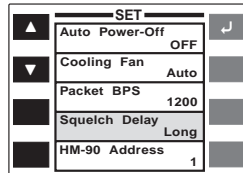

- SET
B
- ① Push [ⒷSET] to enter set mode.
 - ② Push [ⒷSET] or [ⒸENT] to select the ‘Squelch Delay’ item.
 - ③ Push [▲] or [▼] to set the squelch delay to “Long” or “Short.”
 - ④ Push [ⒶCLR] to exit set mode.

■ Sub band mute

The sub band mute function automatically cuts out sub band AF signals when a main band signal is received.

“” appears while the sub band mute is activated.

- ① Push [(DISP)SET] for 2 sec. to enter set mode.
 - Push [CHG/L] if [(DISP)SET] is not displayed.
- ② Push [▲] or [▼] to select the ‘Sub Band Mute’ item.
 - Left-hand tuning dial can also select the item.
- ③ Rotate the right-hand tuning dial to turn the sub band mute function ON or OFF.
- ④ Push [↵] to exit set mode.

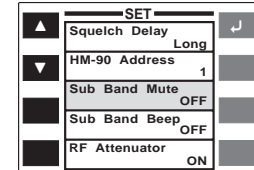

SET
B

- ① Push [ⒷSET] to enter set mode.
- ② Push [ⒷSET] or [ⒸENT] to select the ‘Sub Band Mute’ item.
- ③ Push [▲] or [▼] to turn the sub band mute function ON or OFF.
- ④ Push [ⒶCLR] to exit set mode.

■ Sub band busy beep

The sub band busy beep sounds when the sub band's squelch is closed to inform you that the sub band's squelch has been opened.

- ① Push [(DISP)SET] for 2 sec. to enter set mode.
 - Push [CHG/L] if [(DISP)SET] is not displayed.
- ② Push [▲] or [▼] to select the 'Sub Band Beep' item.
 - Left-hand tuning dial can also select the item.
- ③ Rotate the right-hand tuning dial to turn the sub band busy beep ON or OFF.
- ④ Push [↵] to exit set mode.

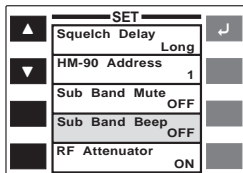

- ① Push [ⓅSET] to enter set mode.
- ② Push [ⓅSET] or [ⓈENT] to select the 'Sub Band Beep' item.
- ③ Push [▲] or [▼] to turn the sub band busy beep ON or OFF.
- ④ Push [ⓂCLR] to exit set mode.

■ Automatic RF attenuator

The attenuator prevents a desired signal from distorting when very strong signals are near the desired frequency, etc.

The transceiver's RF attenuator is linked to the [SQL] setting. The attenuator is automatically activated when [SQL] is rotated clockwise past the 12 o'clock position. Approx. 10 dB attenuation is obtained at full rotation. This function can be turned ON or OFF in set mode.

- ① Push [(DISP)SET] for 2 sec. to enter set mode.
 - Push [CHG/L] if [(DISP)SET] is not displayed.
- ② Push [▲] or [▼] to select the 'RF Attenuator' item.
 - Left-hand tuning dial can also select the item.
- ③ Rotate the right-hand tuning dial to turn the automatic RF attenuator ON or OFF.
- ④ Push [↵] to exit set mode.

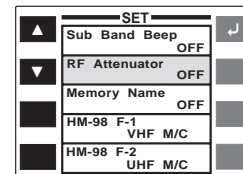

- ① Push [ⓅSET] to enter set mode.
- ② Push [ⓅSET] or [ⓈENT] to select the 'RF Attenuator' item.
- ③ Push [▲] or [▼] to turn the automatic RF attenuator ON or OFF.
- ④ Push [ⓂCLR] to exit set mode.

■ Memory name indication

The transceiver can display memory names programmed in memory or call channels. (p. 32)

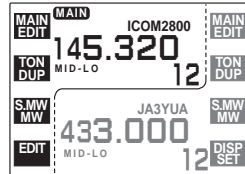

- ① Push [(DISP)SET] for 2 sec. to enter set mode.
 - Push [CHG/L] if [(DISP)SET] is not displayed.
- ② Push [▲] or [▼] to select the 'Memory Name' item.
 - Left-hand tuning dial can also select the item.
- ③ Rotate the right-hand tuning dial to turn the memory name indication ON or OFF.
- ④ Push [↵] to exit set mode.

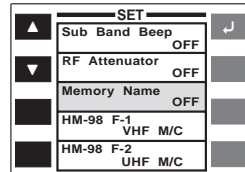

SET
B

- ① Push [Ⓑ SET] to enter set mode.
- ② Push [Ⓑ SET] or [Ⓒ ENT] to select the 'Memory Name' item.
- ③ Push [▲] or [▼] to turn the memory name indication ON or OFF.
- ④ Push [Ⓐ CLR] to exit set mode.

■ HM-98 [F-1]/[F-2] keys

Switches on the transceiver's front panel can be assigned to the HM-98 [F-1] and [F-2] keys. The following can be assigned:

V/U MAIN : [MAIN (SCP)]	V/U V/MHz : [V/MH (TS)]
V/U M/C : [M/C (SCN)]	V/U MONI : [MONI (LOW)]
V/U EDIT : [MAIN (EDIT)]	V/U TONE : [TON (DUP)]
V/U MW : [S.MW (MW)]	DTMF : [DTMF]
DISP : [DISP (SET)]	Up : Microphone's up
Dn : Microphone's down	

- ① Push [(DISP)SET] for 2 sec. to enter set mode.
 - Push [CHG/L] if [(DISP)SET] is not displayed.
- ② Push [▲] or [▼] to select the 'HM-98 F-1' or 'F-2' item.
 - Left-hand tuning dial can also select the item.
- ③ Rotate the right-hand tuning dial to select the desired function.
- ④ Push [↵] to exit set mode.

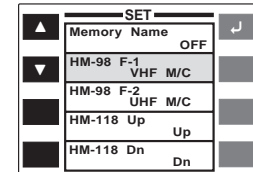

SET
B

- ① Push [Ⓑ SET] to enter set mode.
- ② Push [Ⓑ SET] or [Ⓒ ENT] to select the 'HM-98 F-1' or 'F-2' item.
- ③ Push [▲] or [▼] to select the desired function.
- ④ Push [Ⓐ CLR] to exit set mode.

15 OTHER FUNCTIONS

■ HM-97/118 [UP]/[DN] keys

Switches on the transceiver's front panel can be assigned to the HM-97/118 [UP] and [DN] keys. The following can be assigned:

V/U MAIN	: [MAIN(SCP)]	V/U V/MHz	: [V/MH(TS)]
V/U M/C	: [M/C(SCN)]	V/U MONI	: [MONI(LOW)]
V/U EDIT	: [MAIN(EDIT)]	V/U TONE	: [TON(DUP)]
V/U MW	: [S.MW(MW)]	DTMF	: [DTMF]
DISP	: [DISP(SET)]	Up	: Microphone's up
Dn	: Microphone's down		

- ① Push [(DISP)SET] for 2 sec. to enter set mode.
 - Push [CHG/L] if [(DISP)SET] is not displayed.
- ② Push [▲] or [▼] to select the 'HM-118 Up' or 'Dn' item.
 - Left-hand tuning dial can also select the item.
- ③ Rotate the right-hand tuning dial to select the desired function.
- ④ Push [↵] to exit set mode.

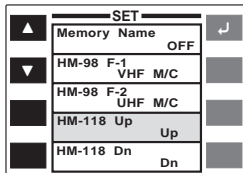

- ① Push [ⓂSET] to enter set mode.
- ② Push [ⓂSET] or [ⓂENT] to select the 'HM-118 Up' or 'Dn' item.
- ③ Push [▲] or [▼] to select the desired function.
- ④ Push [ⓂCLR] to exit set mode.

▨ [UP] or [DN] key assignment is available for the microphones which have [UP]/[DN] switches except the HM-98.

■ Display contrast

The contrast of the LCD can be adjusted from 0% to 100% in 3 or 4% steps. Adjust contrast to suit lighting conditions and personal preferences.

- ① Push [DISP] to enter display set mode.
 - Push [CHG/L] if [DISP] is not displayed.
- ② Push [▲] to select the 'Contrast' item.
 - Left-hand tuning dial can also select the item.

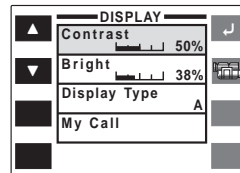

- ③ Rotate the right-hand tuning dial to select the desired contrast.
- ④ Push [↵] to exit display set mode.

■ Display brightness

The brightness of the LCD can be adjusted from 0% to 100% in 3 or 4% steps. Adjust brightness to suit lighting conditions and personal preferences.

- ① Push [DISP] to enter display set mode.
 - Push [CHG/L] if [DISP] is not displayed.
- ② Push [▲] or [▼] to select the 'Bright' item.
 - Left-hand tuning dial can also select the item.
- ③ Rotate the right-hand tuning dial to select the desired brightness.
- ④ Push [↵] to exit display set mode.

■ Indication type

The indication type can be selected from 4 types.

- ① Push [DISP] to enter display set mode.
 - Push [CHG/L] if [DISP] is not displayed.
- ② Push [▲] or [▼] to select the 'Display Type' item.
 - Left-hand tuning dial can also select the item.
- ③ Rotate the right-hand tuning dial to select the desired indication type.
- ④ Push [↵] to exit display set mode.

■ My call function

The opening title when turning power ON can be changed to your call sign, etc. Up to 8 characters can be programmed.

- ① Push [DISP] to enter display set mode.
 - Push [CHG/L] if [DISP] is not displayed.
- ② Push [▼] to select the 'My Call' item.

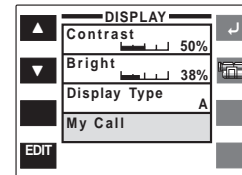

- Left-hand tuning dial can also select the item.
- ③ Push [EDIT] to enter programming mode.
 - The first character of the name flashes.
 - ④ Rotate the right-hand tuning dial to select the desired character.
 - A to Z, 0 to 9, – (hyphen) and space are available.
 - ⑤ Push [▶] to advance to the next character.
 - Push [◀] to select the previous character.
 - ⑥ Repeat ④ and ⑤ until the desired name is input.
 - ⑦ Push [↵] to program the name and exit programming mode.

■ Packet operation

◇ Data speed

For packet operation, the transceiver can be set to one of two data speeds: 1200 bps (default) or 9600 bps.

- ① Push [(DISP)SET] for 2 sec. to enter set mode.
 - Push [CHG/L] if [(DISP)SET] is not displayed.
- ② Push [▲] or [▼] to select the 'Packet BPS' item.
 - Left-hand tuning dial can also select the item.
- ③ Rotate the right-hand tuning dial to select the desired data speed.
- ④ Push [↵] to exit set mode.

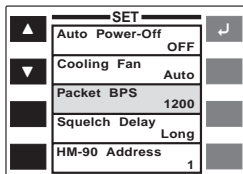

- ① Push [ⓈSET] to enter set mode.
- ② Push [ⓈSET] or [ⓈENT] to select the 'Packet BPS' item.
- ③ Push [▲] or [▼] to select the desired data speed.
- ④ Push [ⓈCLR] to exit set mode.

/// For 1200 bps operation—

- Disconnect the microphone plug from the microphone connector during data transmission, otherwise the data signal and voice signal are simultaneously transmitted.

/// For 9600 bps operation—

- When the transceiver is set for 9600 bps data transmission in set mode, the microphone signal is automatically cut. Therefore, it is not necessary to disconnect the microphone plug from the connector in this case.
- When pushing [PTT] during data transmission, data transmission is interrupted and voice signals have priority.

◇ 1200 bps packet operation

① Connect the transceiver and a TNC as illustrated below.

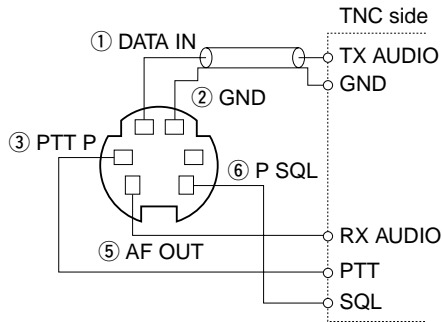

- ② Set the TNC for transmit.
- ③ Set transmit delay on the TNC to 30–50.
- ④ Adjust the TNC frequency deviation if necessary.

• **When using a deviation meter:**

Adjust the output of the TNC so that frequency deviation is in the range ± 3 to 4 kHz.

• **When NOT using a deviation meter:**

A receiver or transceiver is needed to monitor the transmission—compare the received audio output level when receiving a TNC modulated signal with high level voice signals using the microphone. Then adjust the TNC modulated signal to a lower level than the voice modulated signal.

- Read the instructions supplied with your TNC carefully before attempting packet operation with the transceiver.
- Pin ⑤ AF OUT is for 1200 bps operation only. This pin cannot be used for 9600 bps operation.
- Over modulation may degrade signal quality. If you find that many transmissions are failing, re-adjust the modulation level.

15 OTHER FUNCTIONS

◇ 9600 bps high speed packet operation

The transceiver supports 2 modes of 9600 bps packet operation: G3RUH and GMSK.

- ① Connect the transceiver and a TNC as illustrated below.

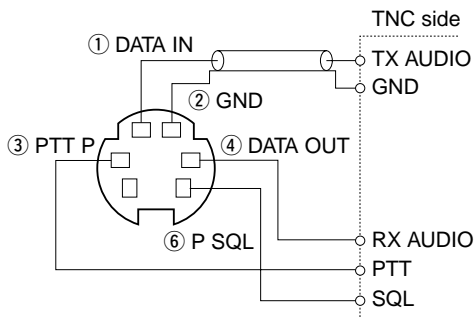

- ② G3RUH mode can handle 16 kinds of modulated wave forms in order to maintain a communication link.
- ③ Set transmit delay on the TNC to 30–50.
- ④ Adjust the TNC frequency deviation if necessary (see page at right).

- When using the PTTP terminal for packet operation, no voice signals are transmitted from the microphone.
- When pushing [PTT] during data transmission, data transmission is interrupted and the voice signal takes priority.
- Read the instructions supplied with your TNC carefully before attempting packet operation with the transceiver.
- Pin ④ DATA OUT is for 9600 bps operation only. This pin cannot be used for 1200 bps operation.

◇ Adjusting the transmit signal output from the TNC

When setting data transmission speed to 9600 bps, the data signal coming from the TNC is applied exclusively to the internal limiter circuitry to automatically maintain band width.

NEVER apply data levels from the TNC of over 0.6 V p-p, otherwise the transceiver will not be able to maintain the band width and may possibly interfere with other stations.

1. When using a level meter or synchroscope, adjust the TX audio output level (DATA IN level) from the TNC as follows.

- 0.4 V p-p (0.2 V rms) : recommended level
- 0.2 V p-p–0.5 V p-p (0.1 V rms–0.25 V rms) : acceptable level

2. When NOT using a measuring device.

- ① Connect the transceiver to a TNC.
- ② Enter a test mode (“CAL”, etc.) on the TNC, then transmit some test data.
- ③ *When the transceiver fails to transmit the test data or transmits sporadically (TX indicator doesn't appear or flashes):*
 - Decrease the TNC output level until the transmit indicator lights continuously.

When transmission is not successful even though the TX indicator lights continuously:

 - Increase the TNC output level.

■ Video monitor function

The LCD can be used as a video monitor for an NTSC or PAL video signal.

- NTSC : U.S.A., Asia, Latin America, Korea and Taiwan versions
- PAL : Europe and Australia versions

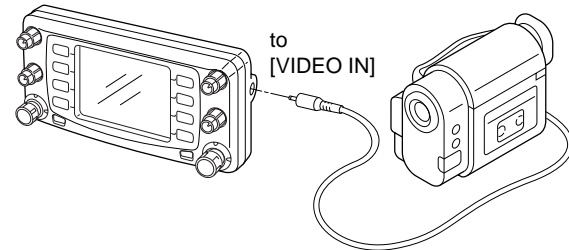

- ① Push [DISP] to enter display set mode.
 - Push [CHG/L] if [DISP] is not displayed.
- ② Push [] to monitor a video signal.
 - The video signal is displayed on the LCD.
- ③ Push any switch except [POWER] to return to display set mode.
- ④ Push [↵] to exit display set mode.

15 OTHER FUNCTIONS

■ Demonstration display

A demonstration function is available at power ON. This function gives you a quick visual introduction to the function display indicators.

- ① While pushing [CHG/L], push [POWER] to turn power ON.
 - The transceiver cycles through a visual tour of the function display indicators.
- ② Push any switch to exit demonstration mode and enter the normal operating condition temporarily.

▨ The transceiver automatically returns to demonstration mode after 2 min. in which no operations are performed.
▨ To deactivate the demonstration display permanently, turn power OFF, then while pushing [CHG/L], turn power ON again.

■ AM/FM narrow mode

FM narrow mode is only available for the Europe version. AM mode (receive only) is only available for the U.S.A. and S. America versions. Typically, AM mode is used for the air band (118–135.995 MHz).

When pushing [PTT], a beep tone sounds indicating the mode is AM mode. The transceiver cannot transmit in AM mode.

- ① Select the mode/channel you wish to set the mode to, such as VFO mode or memory/call channel.
- ② Push the desired band's [(MAIN)EDIT] for 2 sec. to enter the edit screen.
 - Push [CHG/L] if [(MAIN)EDIT] is not displayed.
- ③ Push [MODE] to set the mode to FM wide/FM narrow or AM/FM wide.
- ④ If you want to set other channels, rotate the right-hand tuning dial. Repeat ③ to select the desired frequency.
- ⑤ Push [↵] to exit the edit screen.

▨ The Europe version of the IC-2800H comply with European regulations regarding narrow FM bandwidth operation on amateur transceivers. Wide and narrow FM operation differ in specifications.

■ Fuse replacement

If the fuse blows or the transceiver stops functioning, find the source of the problem if possible, and replace the damaged fuse with a new, rated one (FGB 20 A) as shown below.

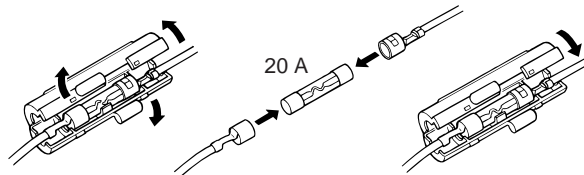

■ Partial reset

If you want to initialize the operating conditions (VFO frequency, VFO settings, set mode contents) without clearing the memory contents, a partial resetting function is available for the transceiver.

Band conditions can be reset independently.

◇ VHF band partial resetting

- ➔ While pushing the 2nd switch from the top on the left side, turn power ON to partially reset the transceiver.
 - “144M VFO Clear” appears when resetting the VHF band condition.

◇ UHF band partial resetting

- ➔ While pushing the 2nd switch from the top on the right side, turn power ON to partially reset the transceiver.
 - “430M (440M) VFO Clear” appears when resetting the UHF band condition.

◇ Partial resetting of both bands

- ➔ While pushing the 2nd switches from the top on both the left and right sides, turn power ON to partially reset the transceiver.
 - “VFO Clear” appears when resetting the VHF and UHF band condition.

■ All reset

The function display may occasionally display erroneous information (e.g. when first applying power). This may be caused externally by static electricity or by other factors.

If this problem occurs, turn power OFF. After waiting a few seconds, turn power ON again. If the problem persists, perform the following procedure.

- Partial resetting is also available. See previous section for details.

CAUTION: Resetting the transceiver **CLEARs** all memory information and initializes all values in the transceiver.

- ➔ While pushing the 3rd switches from the top on both the left and right sides, turn power ON to reset the CPU.
 - “Memory Clear” appears when resetting the CPU.

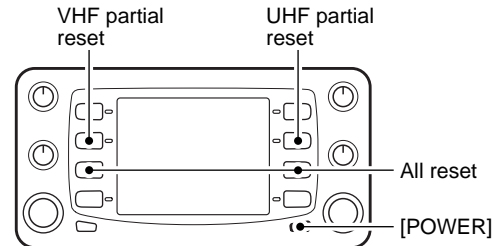

■ Getting started

- ◇ This cloning software is designed to perform data setting and cloning for the IC-2800H DUAL BAND FM transceiver.
- ◇ HELP WINDOW: Each item has a help window to describe functions and operation.

■ System requirements

To use this program, the following hardware and software are required:

- IBM PC/AT compatible computer
- An RS-232C serial port
- Microsoft® Windows® 95 or Microsoft® Windows® 98
- Intel i486DX4 processor or faster
- At least 16 MB RAM
- At least 640 × 480 pixel display
- OPC-478 CLONING CABLE

■ Software installation

NOTE: Before using the program, make a backup copy of the original disk. After making a backup copy, keep the original disk in a safe place.

NOTE: Depending on your Windows® system files, the PC may require rebooting. In this case, repeat the installation from the beginning.

- ① Boot up Windows.
 - Quit all applications when Windows is running.
- ② Insert backup disk into the appropriate floppy drive.
- ③ Select 'Run' from the [Start] menu.
- ④ Type the setup program name with full path name, then press the [Enter] key. (A:\SETUP [Enter])
- ⑤ Follow the prompts.
- ⑥ Program group 'CS-2800' appears in the 'Programs' folder of the start menu.

■ Connections

All cloning operations are performed from the computer's keyboard—the operation required on the transceiver side is: while pushing the microphone [UP] switch + the 4th switch from the top on the left side, push [POWER] on the controller.

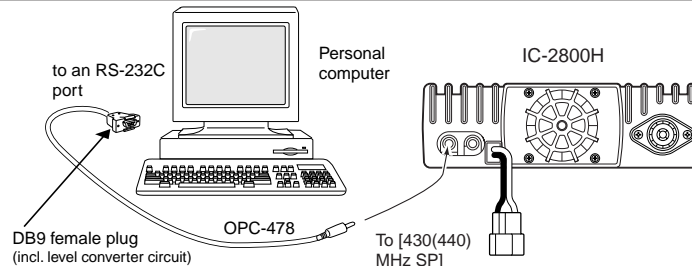

■ COM port/call sign setting

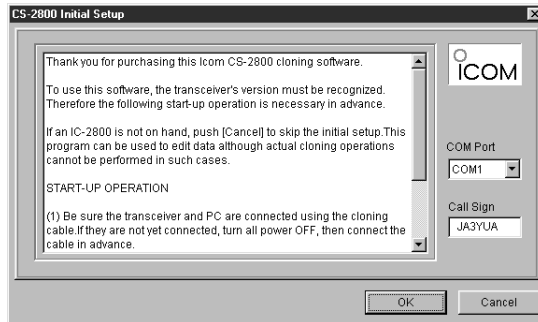

- Set the com port (RS-232C port) number properly.
- Enter your call sign.

/// **NOTE:** 'Check the following' dialog box appears when the RS-232C serial port is not set correctly.

/// **NOTE:** When first using this software, read out all the transceiver cloning data into the PC before starting editing with this cloning software. Otherwise the cloning data may not be cloned properly to the transceiver. (e.g. operating frequency setting, mode selection, etc.)

■ Memory channel list description

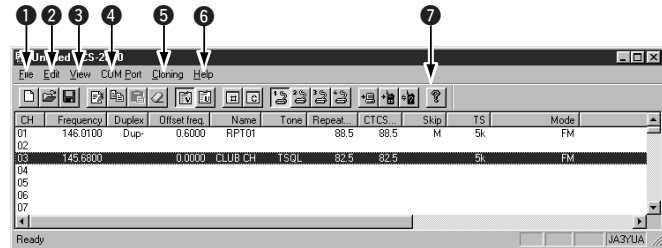

① FILE MENU [File]

Used for turning the software on/off, saving memory channel contents or quitting the program, etc.

② EDIT MENU [Edit]

The memory channel can hold up to 99 channels + 3 pairs of programmed scan edges + 1 call channel.

Each memory channel can be edited (copy, paste, clear, insert and delete) via the edit menu.

③ VIEW MENU [View]

- UHF memory channel list, VHF memory channel list, DTMF autodial, Common settings (p. 79) screens are selectable.

- Turn the tool bar or status bar on/off.

④ COM PORT MENU [COM Port]

Push to display the COM port setting dialog box.

16 CS-2800 CLONING SOFTWARE

5 CLONING MENU [Cloning]

Push to display cloning menu and cloning information dialog box.

6 HELP MENU [Help]

Push to display one point help, help contents, cloning software revision information.

7 Tool bar

Short cut key appears on the tool bar when clicking the tool bar function in the [View] menu.

■ Edit menu

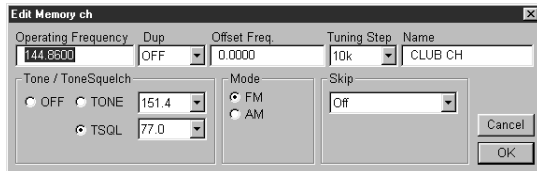

The 'Edit Memory ch' window allows you to edit the memory channel information.

The memory channel list can hold up 99 channels + 3 pairs of programmed scan edges + 1 call channel.

NOTE: 'Narrow FM' is available for the VHF band of the Europe version only.

NOTE: Read all the transceiver cloning data into the PC before starting editing with this cloning software, otherwise

the frequency data may not be cloned properly to your transceiver.

■ DTMF autodial

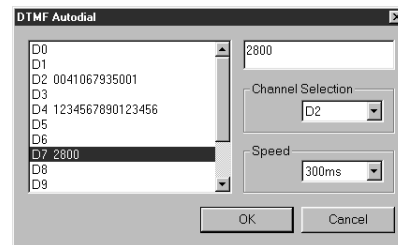

The transceiver has 14 DTMF memory channels (D0–D9, DA–DD) for storage of often-used DTMF codes of up to 16 digits. One of these channels is encoded when the PTT is pushed.

When slow DTMF speeds are required, the transceiver's rate of DTMF transmission can be adjusted.

"E" stands for "*" and "F" stands for "#."

Common settings

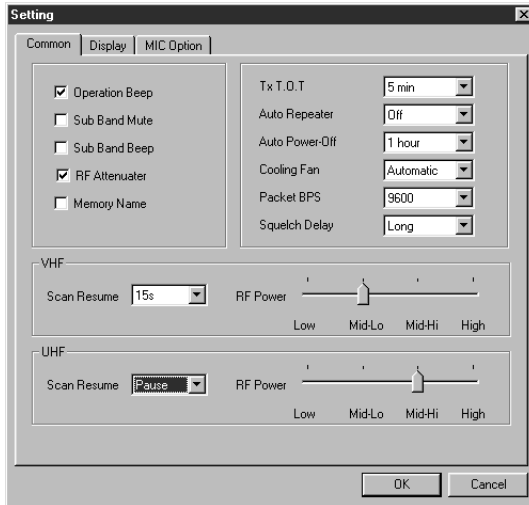

There are 3 setting menus available.

Common : Commonly set items such as operation beeps, sub band mute, sub band beep, RF attenuator, name display, TOT, auto repeater, auto power-off, cooling fan setting, packet data speed, squelch delay, VHF/UHF scan resume timer and RF output power settings.

Display : Sets LCD contrast and brightness.
Select display type. Enter 'Opening Title' and clone 'Comment.'

MIC Option : Switches on the transceiver's front panel can be assigned to the microphone's [F-1]/[F-2] for the HM-98 and [UP]/[DN] for the HM-97 and HM-118/T/TA.

Exiting cloning mode

- ➔ After cloning is finished, push the [UP]/[DN] or [▲]/[▼] on the microphone to exit the cloning mode and to return to normal operating condition.
 - The [POWER] switch does not function in the cloning mode.

DO NOT disconnect the controller cable while in the cloning mode. The transceiver remains in the cloning mode and continues in power ON condition.

17 TROUBLESHOOTING

If your transceiver seems to be malfunctioning, please check the following points before sending it to a service center.

PROBLEM	POSSIBLE CAUSE	SOLUTION	REF.
No power comes on.	<ul style="list-style-type: none"> •Power connector has a poor contact. •Polarity of the power connection is reversed. •Blown fuse. 	<ul style="list-style-type: none"> •Check the connector pins. •Reconnect the power cable observing the proper polarity. Replace the fuse, if damaged. •Check the cause, then replace the fuse. 	— pgs. 15, 74 p. 74
No sound comes from the speaker.	<ul style="list-style-type: none"> •Volume level is too low. •The squelch level is set too tight. •A selective call or squelch function is activated such as tone squelch or pocket beep. 	<ul style="list-style-type: none"> •Rotate [VOL] clockwise. •Open the squelch. •Turn the appropriate function OFF. 	p. 23 p. 23 pgs. 50, 52
Sub band signals are not audible.	<ul style="list-style-type: none"> •The sub band mute function is activated. 	<ul style="list-style-type: none"> •Turn the function OFF. 	p. 65
No contact possible with another station.	<ul style="list-style-type: none"> •The transceiver is set to semi-duplex. •The other station is using tone squelch. 	<ul style="list-style-type: none"> •Set to simplex. •Turn OFF tone squelch. 	p. 26 p. 50
Repeater cannot be accessed.	<ul style="list-style-type: none"> •Wrong offset frequency is programmed. •Wrong subaudible tone frequency is programmed. 	<ul style="list-style-type: none"> •Correct the offset frequency. •Correct the subaudible tone frequency. 	p. 30 p. 29
Frequency cannot be set.	<ul style="list-style-type: none"> •The frequency lock function is activated. •Priority watch is paused on the watching frequency. 	<ul style="list-style-type: none"> •Turn the function OFF. •Push [(PRO)PRIO] or [(MEM)PRIO] to resume the watch. 	p. 19 p. 48
Scan does not operate.	<ul style="list-style-type: none"> •Squelch is open. •The selected programmed scan edge memory channels (e.g. 1A/1B) have the same frequencies. •Only 1 memory channel is programmed or other channels are set as skip channels. 	<ul style="list-style-type: none"> •Set the squelch to the threshold point. •Reset the scan edges. •Program other memory channels or cancel the memory skip function in the desired channels. 	p. 23 p. 44 pgs. 50, 52
Transmission is automatically cut off.	<ul style="list-style-type: none"> •Time-out timer is activated. 	<ul style="list-style-type: none"> •Set the timer to OFF. 	p. 63
Transmission continues even when PTT is released.	<ul style="list-style-type: none"> •One-touch PTT function is activated. 	<ul style="list-style-type: none"> •Turn the function OFF. 	p. 25

HM-90 WIRELESS MICROPHONE

Infrared, full remote control microphone. Wired remote control is also possible.

EX-1759 INFRARED RECEIVER

Used to receive control signals from the HM-90.

EX-1513 INFRARED SUB RECEIVER

Used with the EX-1759 to extend the controllable area.

HM-98 REMOTE CONTROL MICROPHONE

Wired remote control microphone with key backlight. Same as supplied with some versions.

HM-118N HAND MICROPHONE

HM-118TN/TAN DTMF MICROPHONE

HM-95 DTMF MICROPHONE

HM-97 HAND MICROPHONE (with tone call)

HS-62 FLEXIBLE MOBILE MICROPHONE + **HS-15SB** SWITCH BOX + **OPC-589** ADAPTER CABLE

For all-around mobile operation.

MB-17A MOBILE MOUNTING BRACKET

One-touch bracket. Transceiver body easily attached and removed.

MB-65 MOUNTING BASE

Mounts the controller unit in a convenient location. Adjustable angle and direction for optimum positioning.

MB-73 CONTROLLER BRACKET

Mounts the controller to a wall or flat surface. Same as supplied.

SP-10 EXTERNAL SPEAKER

For all-around mobile operation.

CS-2800 CLONING SOFTWARE + **OPC-478** CLONING CABLE

Provides quick and easy programming of items, including memory channels, memory names and set mode contents for local repeater frequencies, etc. via a PC.

OPC-346/OPC-347 DC POWER CABLES (20 A capacity)

OPC-346: 3.0 m (9.8 ft); OPC-347: 7.0 m (23 ft)

OPC-440/OPC-647 MICROPHONE EXTENSION CABLES

OPC-440: 5.0 m (16.4 ft); OPC-647: 2.5 m (8.2 ft)

OPC-872 CONTROLLER EXTENSION CABLE (3.5 m; 11.5 ft)

19 SPECIFICATIONS

◇ General

- Frequency coverage : (Unit: MHz)
 - U.S.A. Transmit 144–148, 430–450*1
 - Receive 118–174*2, 320–530*1
 - S. America Transmit 144–148, 430–440
 - Receive 118–174*2, 400–530*3
 - Europe, Tx/Rx 144–146, 430–440
 - Taiwan
 - Asia Transmit 144–148, 430–440
 - Receive 136–174*2, 430–440
- *1 Specifications guaranteed 440–450 MHz.
- *2 Specifications guaranteed 144–148 MHz.
- *3 Specifications guaranteed 430–440 MHz.
- Mode : FM,
AM (118–135.995; Rx only)
- No. of memory channels : 232 (incl. 12 scan edges, 10 log,
10 repeater and 2 call)
- Tuning steps : 5, 10, 12.5, 15, 20, 25, 30 and 50
kHz
- Frequency stability : ± 10 ppm
(-10°C to $+60^{\circ}\text{C}$; $+14^{\circ}\text{F}$ to $+140^{\circ}\text{F}$)
- Power supply requirement: 13.8 V DC $\pm 15\%$
(negative ground)

- Current drain (VHF/UHF; at 13.8 V DC):
 - Transmit max. power 12.0 A/11.0 A*
 - Receive standby 1.2 A
 - max. audio 1.8 A

* 8.0 A for Taiwan version.

- Antenna connector : SO-239 (50 Ω)
- Data connector : Mini DIN 6-pin
- External video input : PHONO [RCA (75 Ω)]
- Dimensions (projections not included):
 - Controller 140(W) \times 70(H) \times 34(D) mm
5 $\frac{1}{2}$ (W) \times 2 $\frac{3}{4}$ (H) \times 1 $\frac{1}{32}$ (D) in
 - Main unit 140(W) \times 40(H) \times 165.8(D) mm
5 $\frac{1}{2}$ (W) \times 1 $\frac{9}{16}$ (H) \times 6 $\frac{17}{32}$ (D) in
- Weight (approx.) : Controller 290 g; 10.2 oz
Main unit 1.15 kg; 2 lb 9 oz

◇ Transmitter

- Modulation system : Variable reactance
- Output power (VHF/UHF) : High* 50 W/35 W
Mid-H* 20 W (approx.)
Mid-L 10 W (approx.)
Low 5 W (approx.)
- * 25 W (High), 15 W (Mid-H) for both VHF and UHF for Taiwan version.
- Spurious emissions : -60 dB
- Microphone connector : 8-pin modular (600 Ω)

◇ Receiver

- Receive system : Double conversion superheterodyne
- Intermediate frequencies :
 - 1st VHF 15.65 MHz
 - UHF 46.05 MHz
 - 2nd 450 kHz
- Sensitivity : 0.16 μV typical (at 12 dB SINAD)
- Squelch sensitivity : Less than 0.13 μV (at threshold)
- Selectivity :
 - Wide More than 12 kHz/−6 dB
 - Less than 28 kHz/−60 dB
 - Narrow More than 6 kHz/−6 dB
 - (Europe VHF only) Less than 18 kHz/−60 dB
- Spurious and image rejection ratio:
 - More than 60 dB
- Intermodulation rejection ratio:
 - More than 60 dB
- Audio output power : More than 2.4 W at 10% distortion with an 8 Ω load (at 13.8 V DC)
- 144 MHz SP connector : 2-conductor 3.5 (d) mm (1/8")/8 Ω
- 430(440) MHz SP connector : 3-conductor 3.5 (d) mm (1/8")/8 Ω

All stated specifications are subject to change without notice or obligation.

Count on us!

A-5570H-1EX-③
Printed in Japan
© 1999 Icom Inc.

Icom Inc.
1-1-32 Kamiminami, Hirano-ku, Osaka 547-0003 Japan